

LETTO MERCURY

Notice de montage
Assembling scheme



<p>O</p> <p>6MA*20</p> <p>N°32</p>	<p>P ANGOLARE</p> <p>N°4</p>
<p>H PIEDI</p> <p>N°2</p>	<p>X</p> <p>Viti 4.5x40</p> <p>N°12</p>
<p>B</p> <p>6MA*30</p> <p>N°8</p>	<p>M 3.5x30</p> <p>N°8</p> <p>N</p> <p>N°2</p>

4

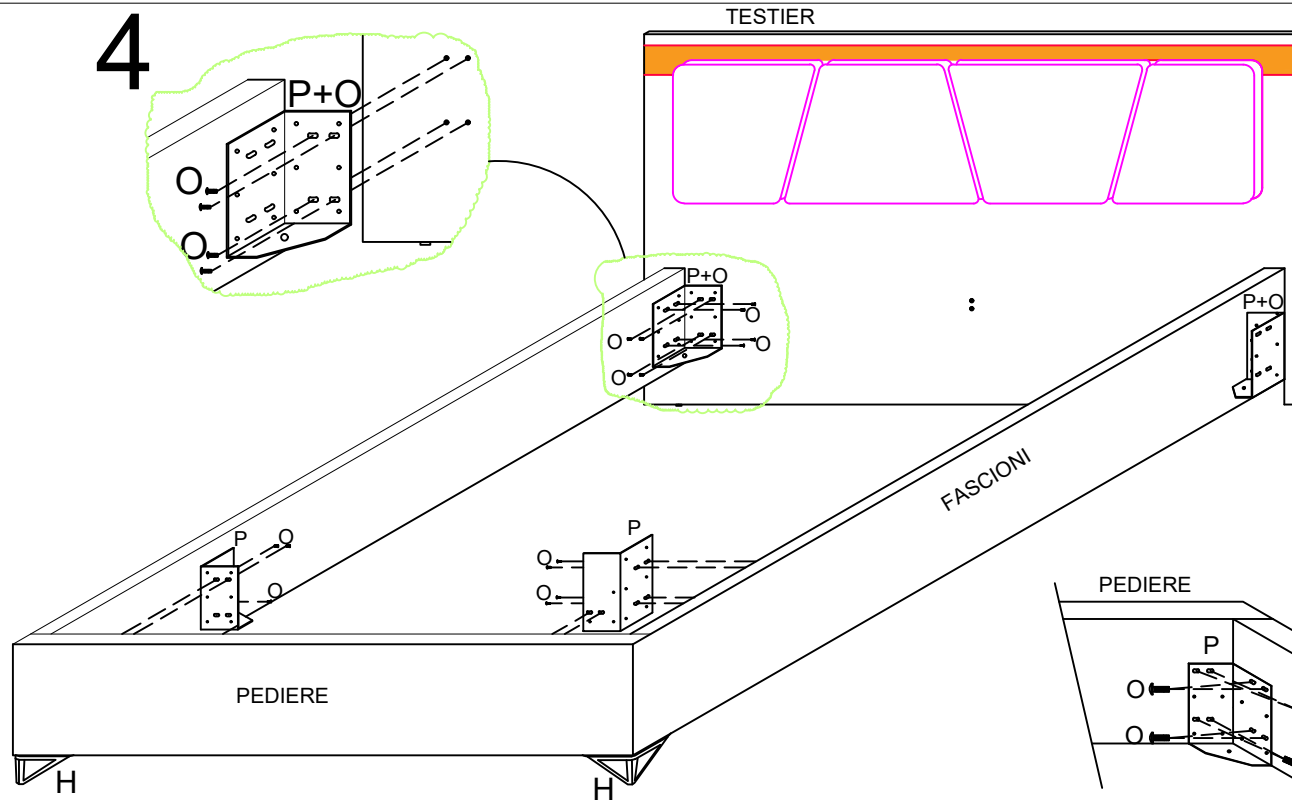

2

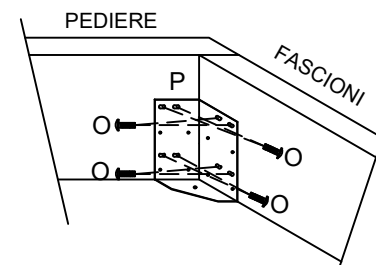

3

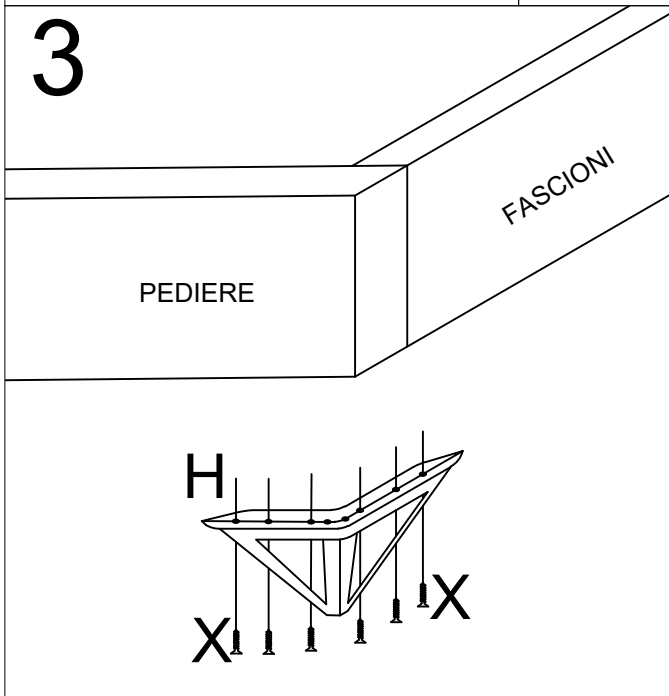



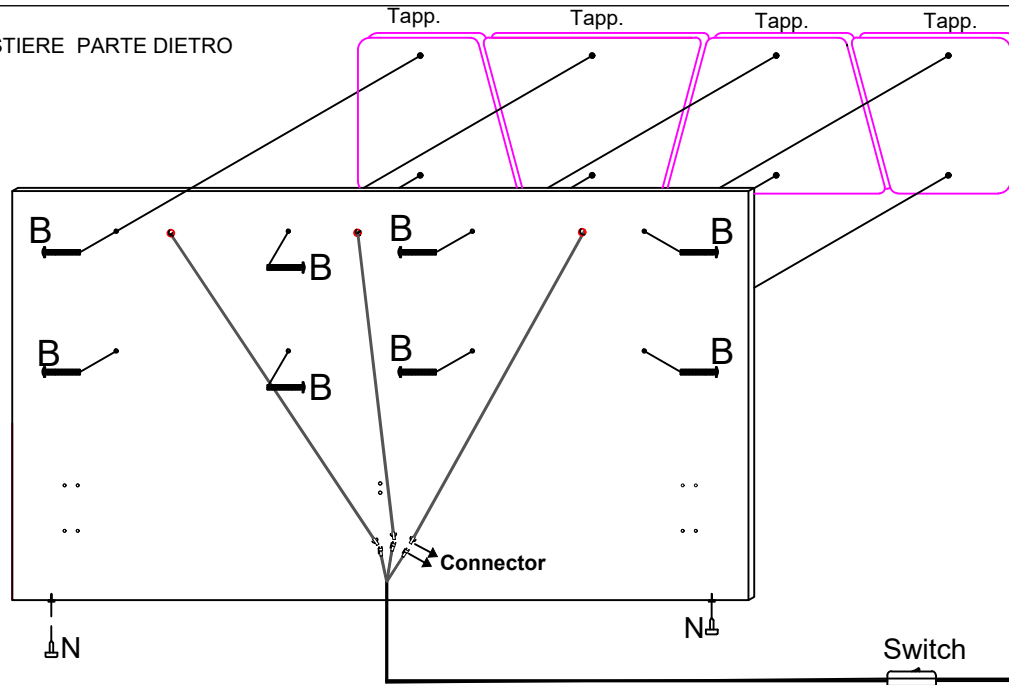









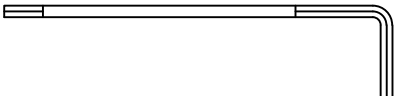











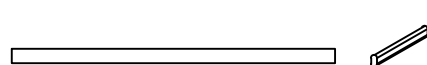

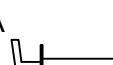





VISTA TESTIERE PARTE DIETRO

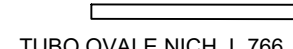

1

Adapter

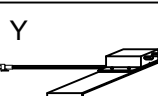
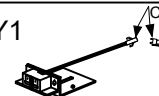
Switch

A NON INCLUSE  N°6	B NON INCLUSE  N°6	M NON INCLUSE  N°6	D NON INCLUSE  N°1		
U  N°16	L 6.3*9  N°16	S D.8x30  N°32	E  N°16	Q Reggitubo  N°4	H 3*20  N°40
I  N°9	O  N°12	P  N°12	N Tappi copriforo D.10 pl. bianco  N°6	R 3,5*15  N°114	C Lastrine Ferro  N°6
Z  TUBO OVALE NICH. L.1219 N°2			X 3,5*50  N°12	SPECCHIERA  Mod. Glamour N°2 Mod. Mercury N°1	
CONF.  x8  x8  x8  x2  x2  x1      Reggitubo  TUBO OVALE NICH. L.766 N°1 					
Y  N°1		Y1  N°1		Y2  N°1	

ARMADIO SCORREVOLE

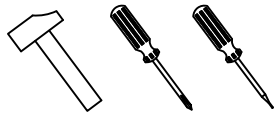

MOD.MERCURY-GLAMOUR

Notice de montage
Assembling scheme

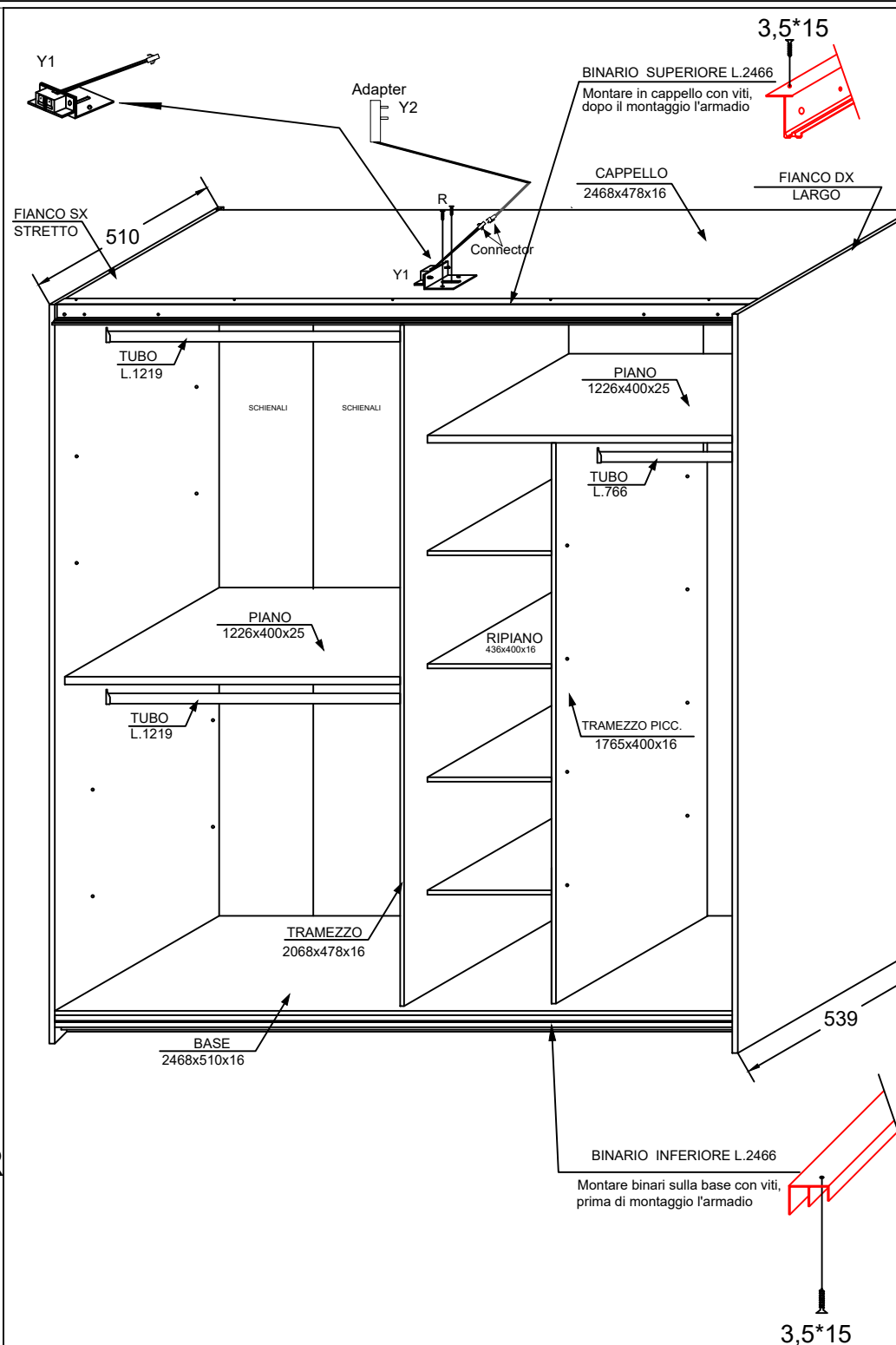

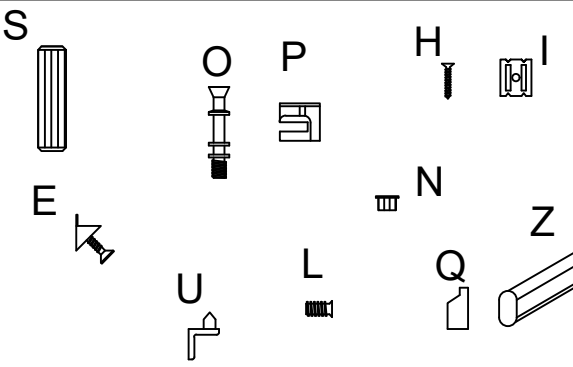

MOD. DELIZIA

Notice de montage
Assembling scheme

3

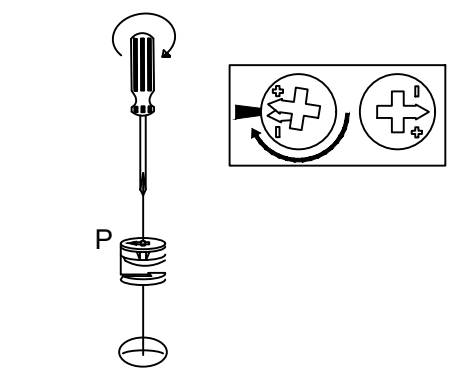
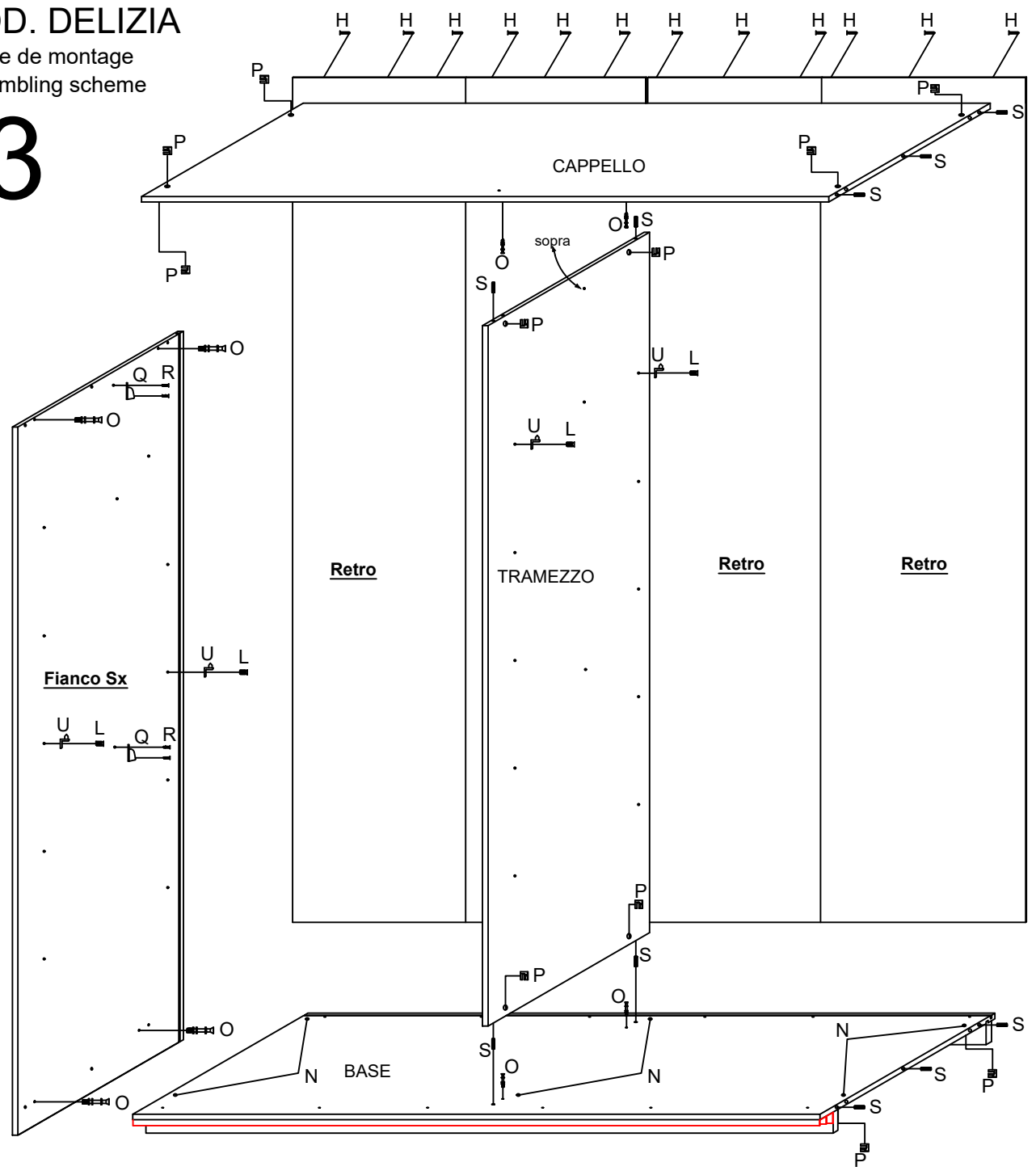

Vista Armadio Dietro

4

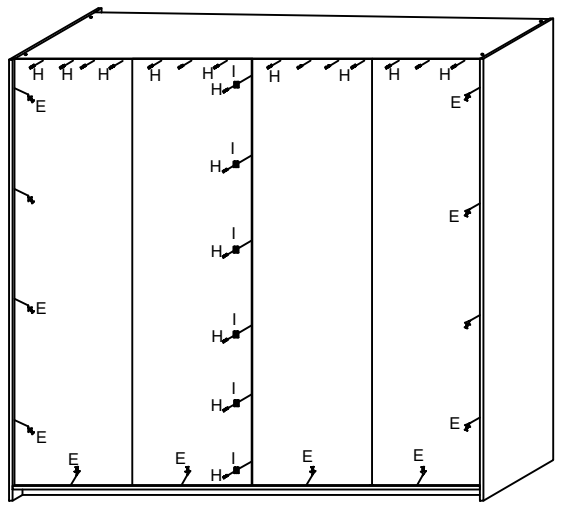

Fianco Dx

MOD. DELIZIA
Notice de montage
Assembling scheme

6

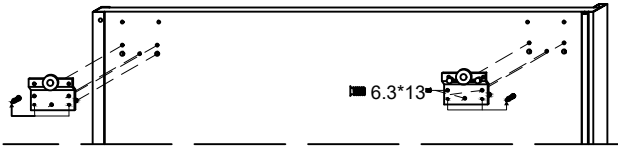

Vista Anta Interno parte Interno

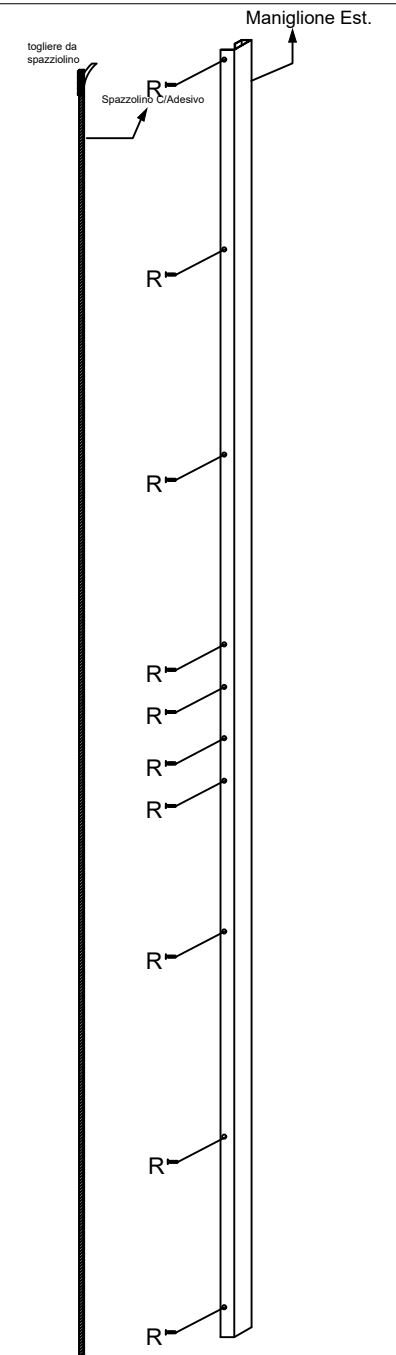
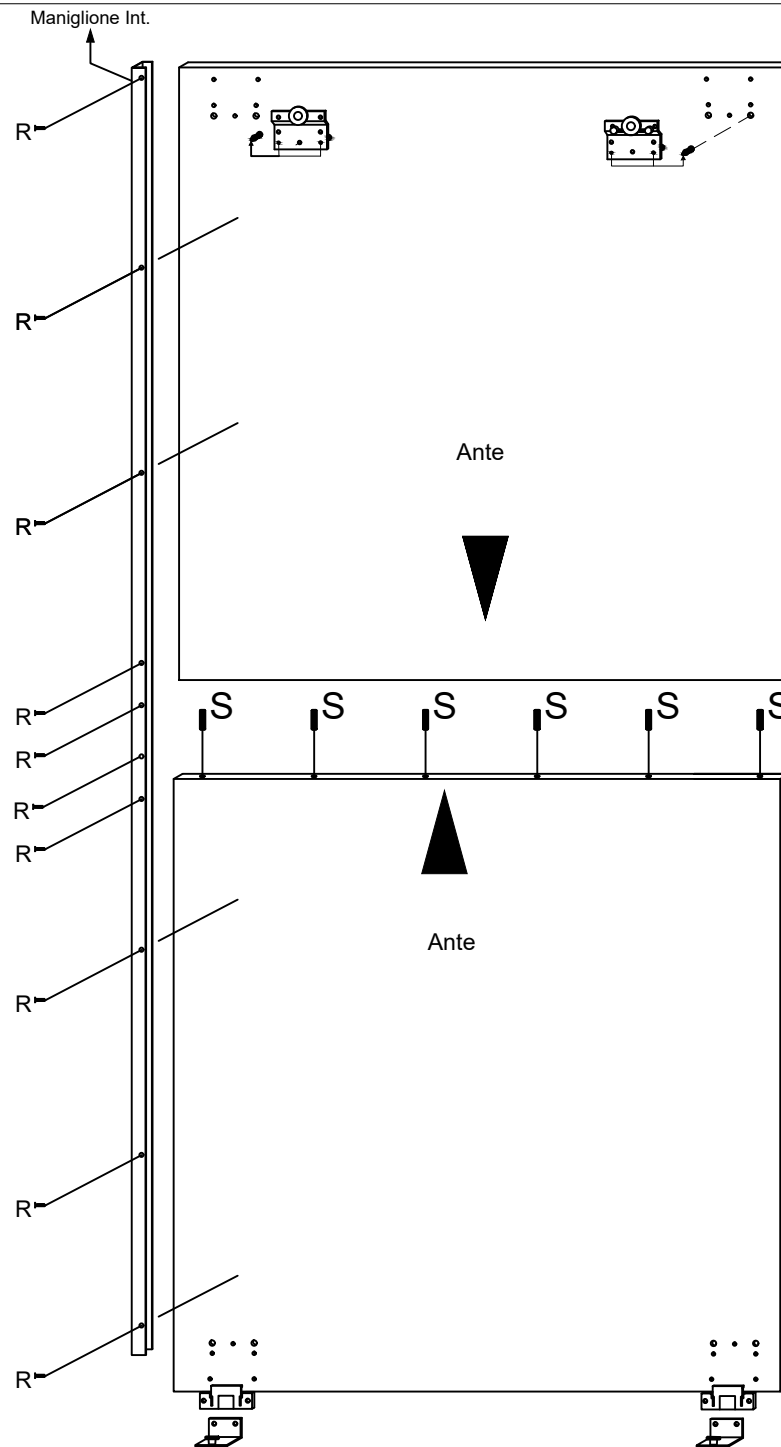
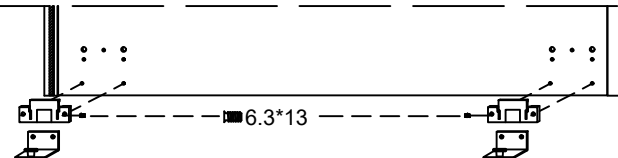
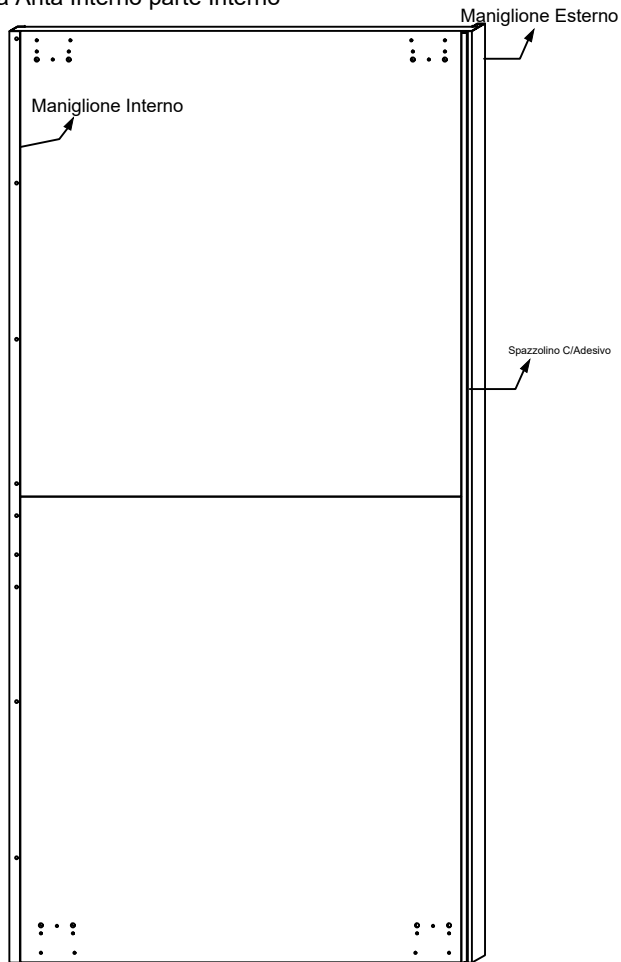

MOD. MERCURY-GLAMOUR

Notice de montage
Assembling scheme

7

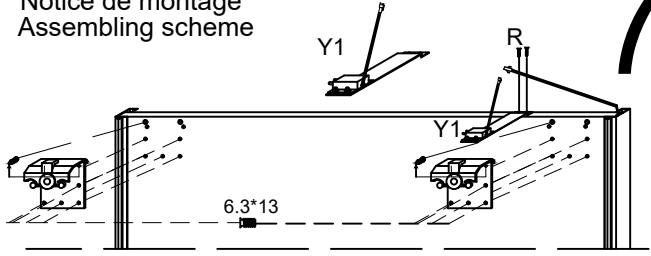

Vista Anta Esterno parte Interno Maniglione Esterno

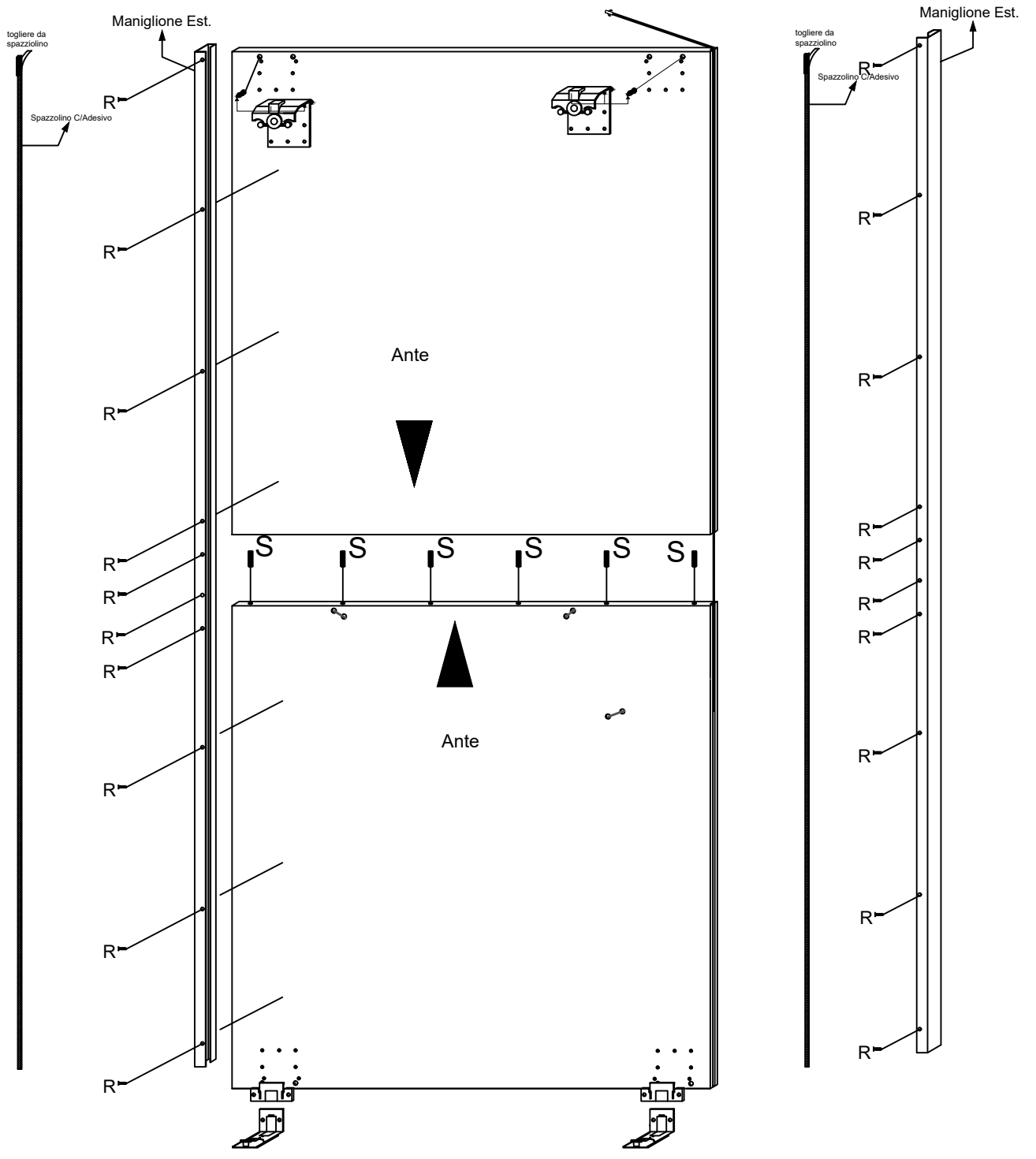
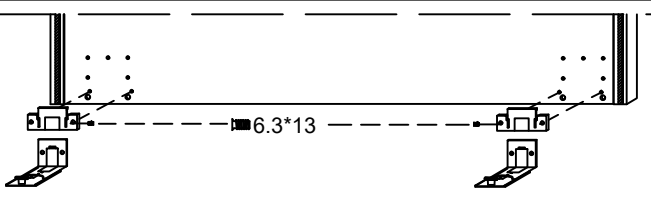
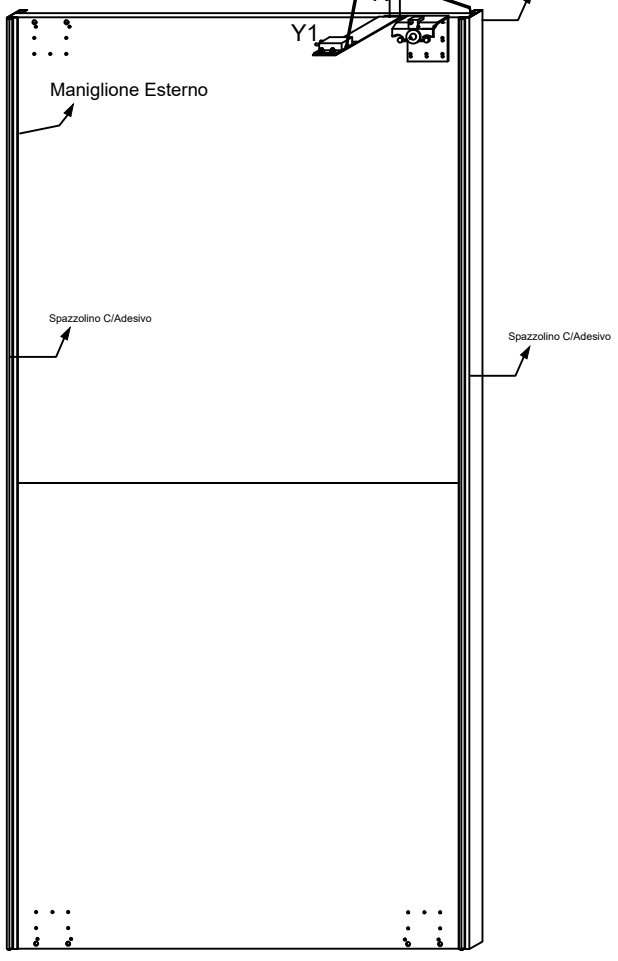

COMODINO MERCURY ZMT.

Notice de montage
Assembling scheme

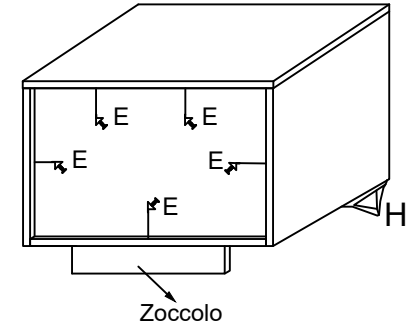
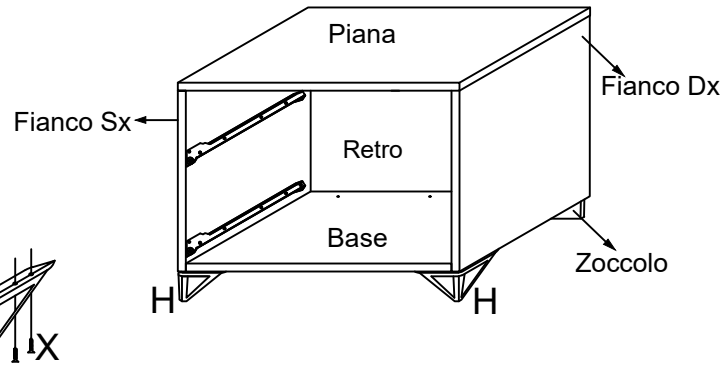
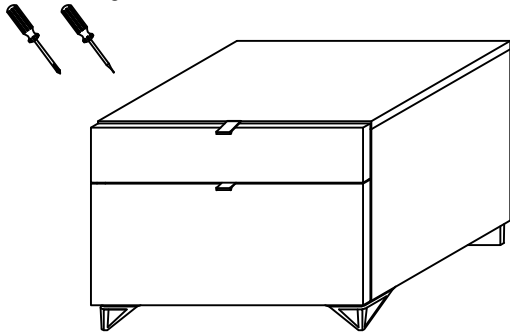

2

MANIGLIE 45 N°2	3.5x12 N°4
B Viti 3.5x15 N°12	A P 15*10 N°4
C 6.3 x9 N°8	P P 15*12 N°8
O N°8	Y Paracolpo Adesivo N°4
E N°16	S N°12
G N°2	H PIEDI N°2
M 3.5x50 N°2	X Viti 4x18 N°12
Z Z-L N°2 Z-R N°2 N°2 Soft	T N°2 R N°2 L
F Cassetto Nr*2 N°1 Cassetto Nr*1 N°1	

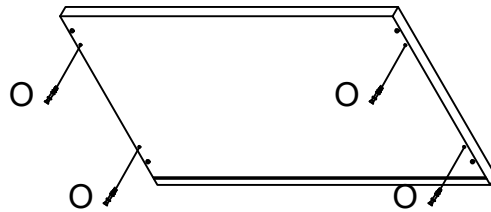
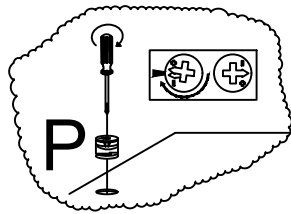

1

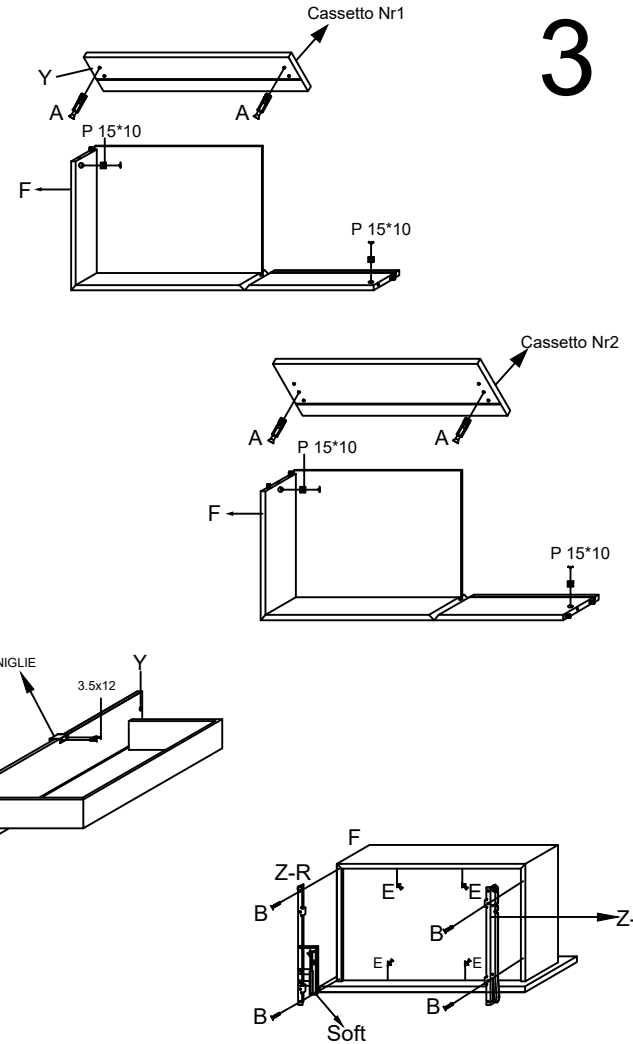
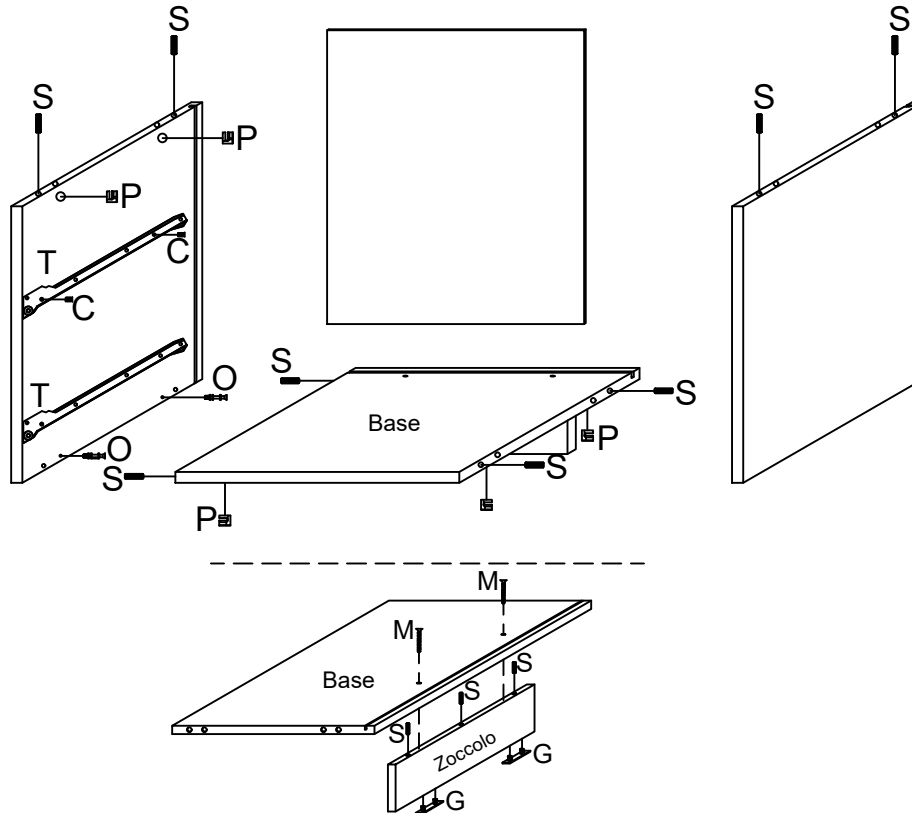

3

COMO MERCURY ZMT.
 Notice de montage
 Assembling scheme

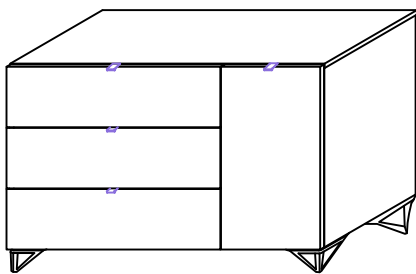

1

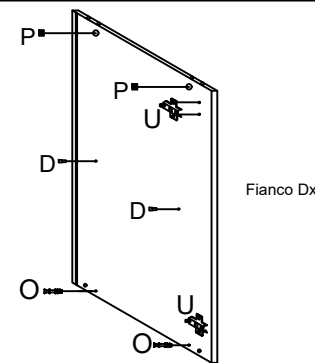
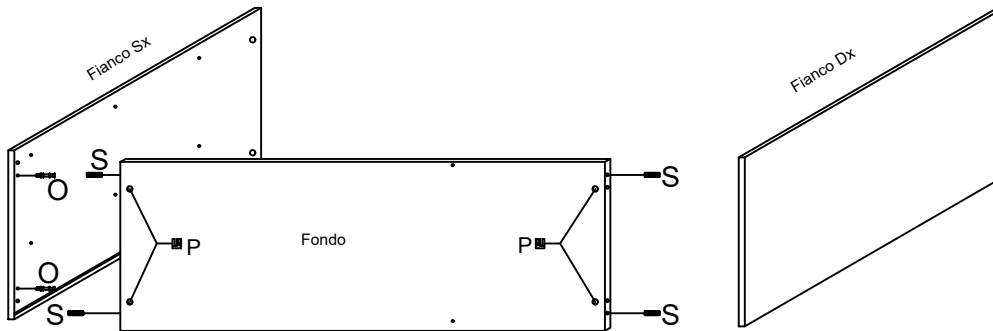

2

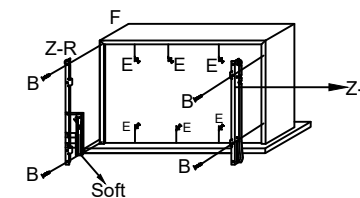
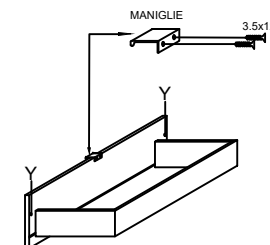
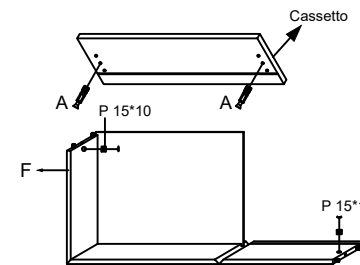
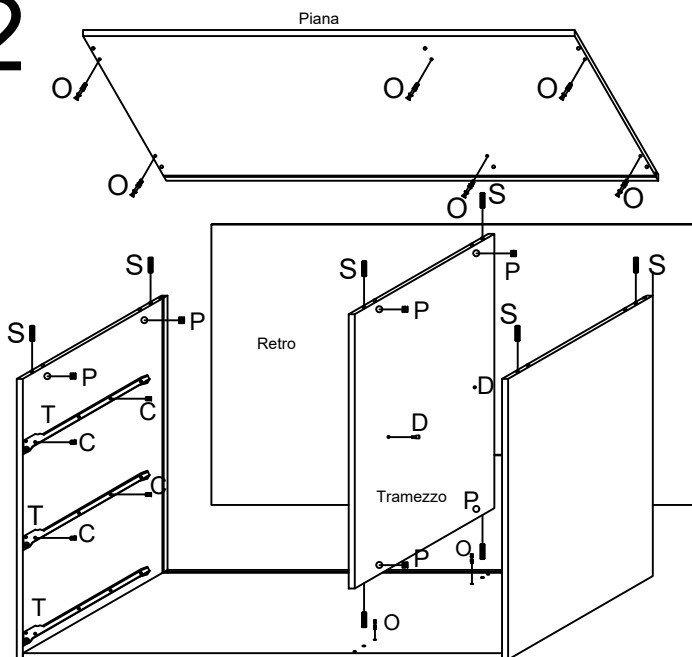

4

3

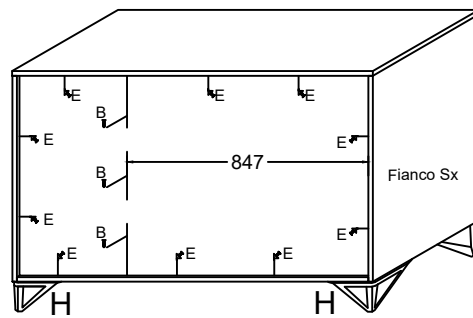

Vista Dietro

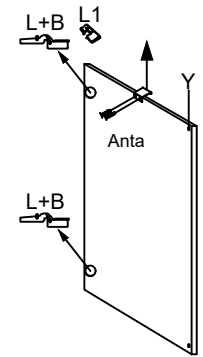
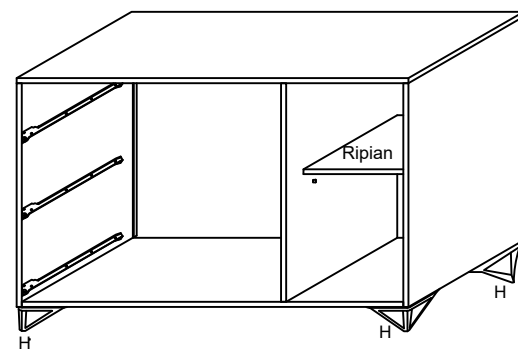

MANIGLIE 45 N°4		3.5x12 N°8	
B 3.5x15 N°24	A N°6	P 15*10 N°6	
C 6.3 x9 N°12	Y Paracolpo Adesivo N°8		
O N°12	P N°12	E Fissaggio Retro-Fondin N°26	
S N°20	X Viti 4x18 N°24		
H PIEDI N°4	Z Z-L N°3 Z-R N°3 N°3 Soft		
F N°3	T N°3 R N°3 L		
U N°2	L N°2	L1 SLOWMOTION ALFA N°1	
M 3.5x35 N°0	D N°4		