

MOD. DELIZIA

Notice de montage
Assembling scheme

1

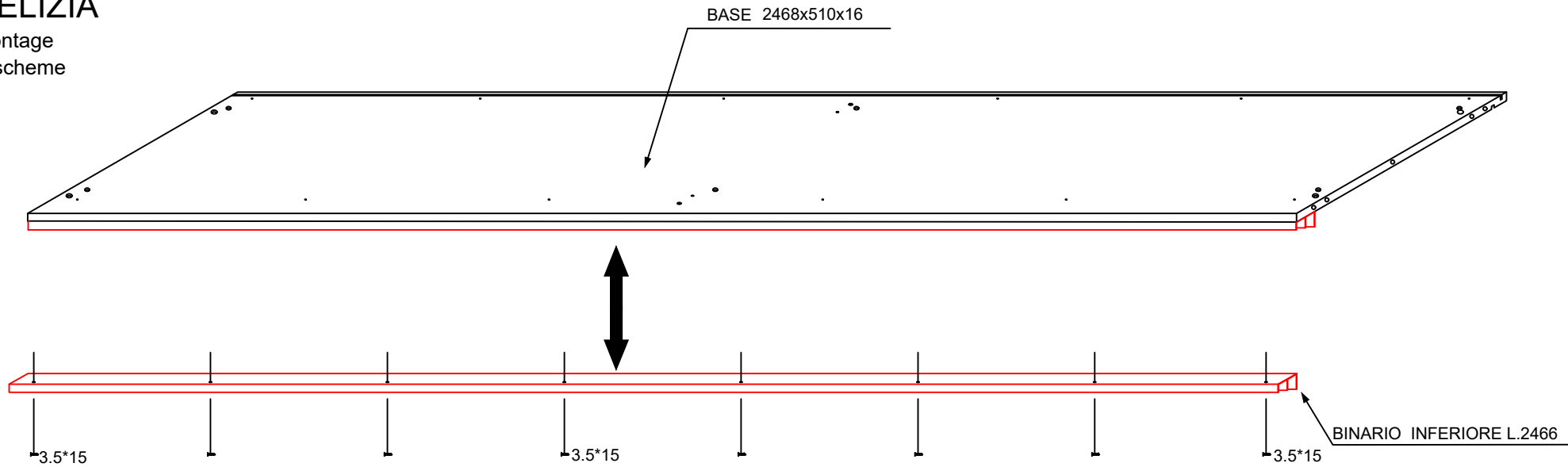

2

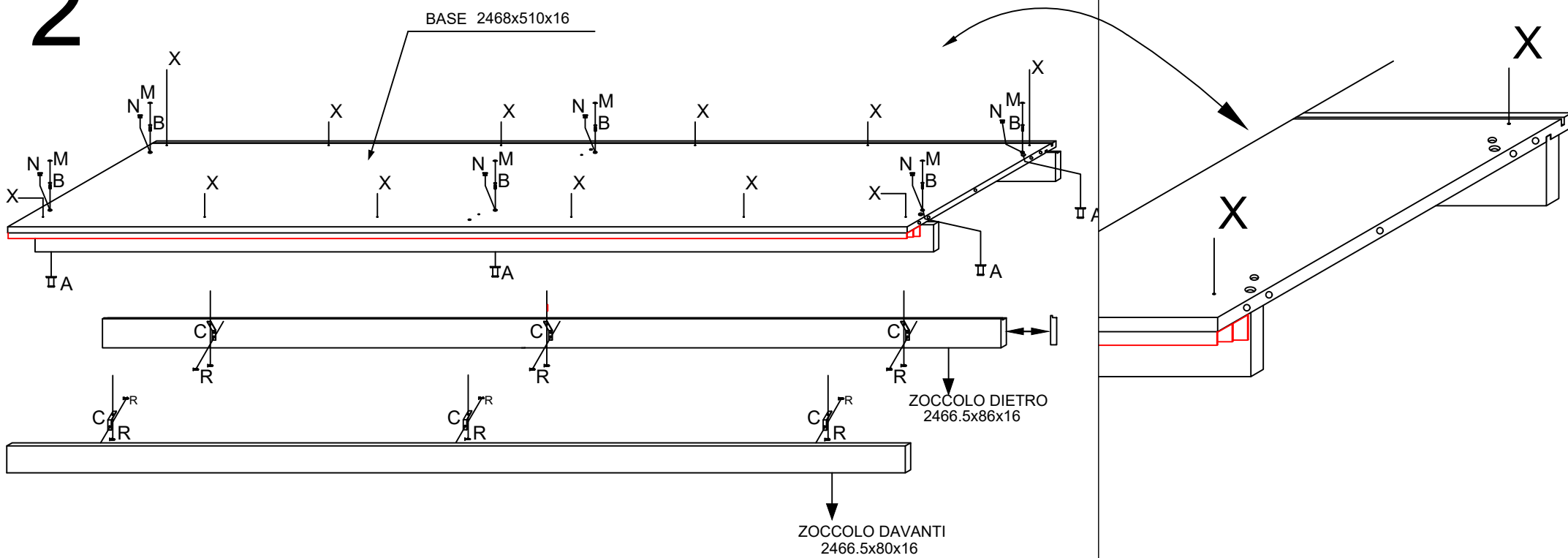

MOD. DELIZIA

Notice de montage
Assembling scheme

5

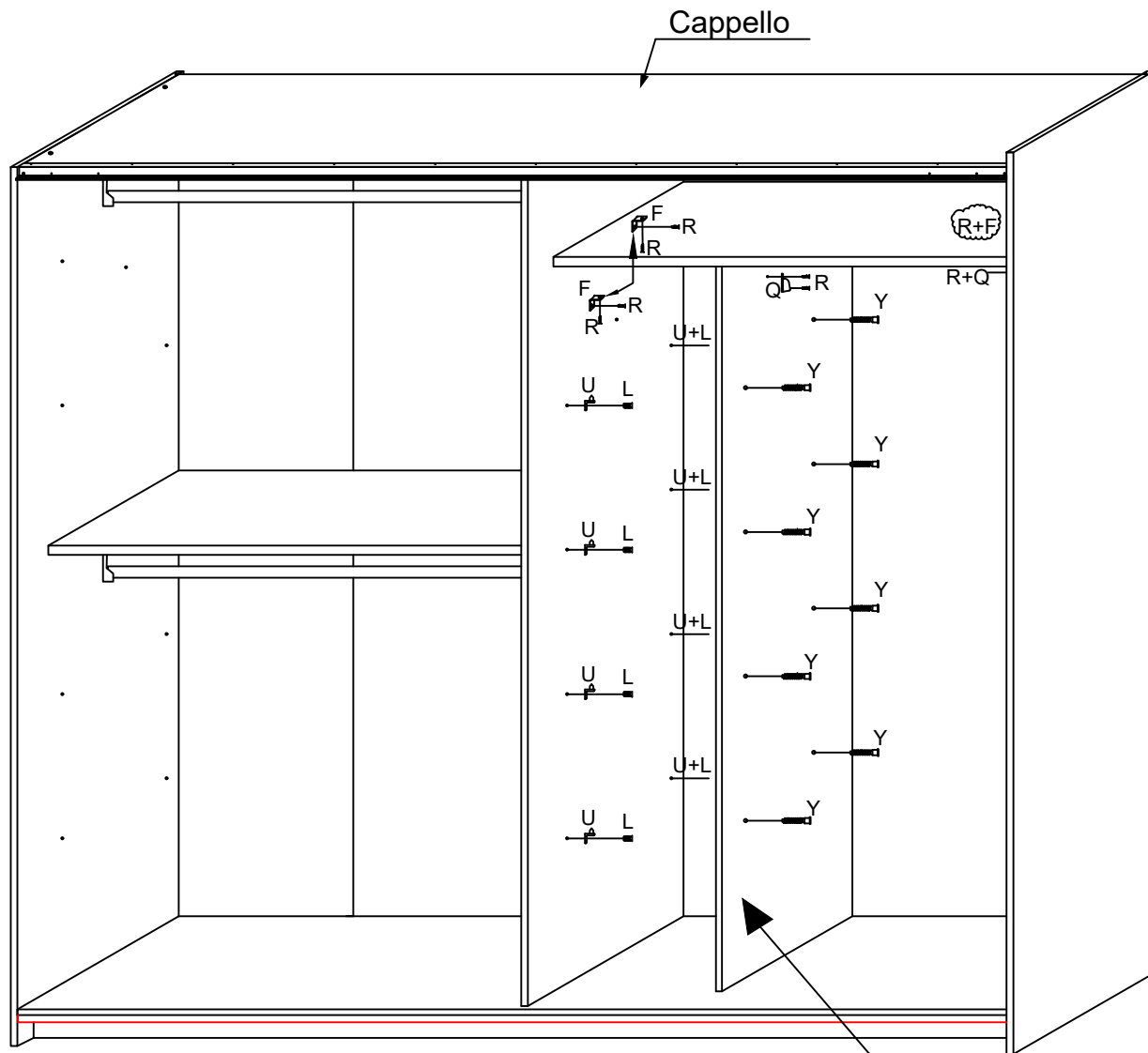

BINARIO SUPERIORE L.2466

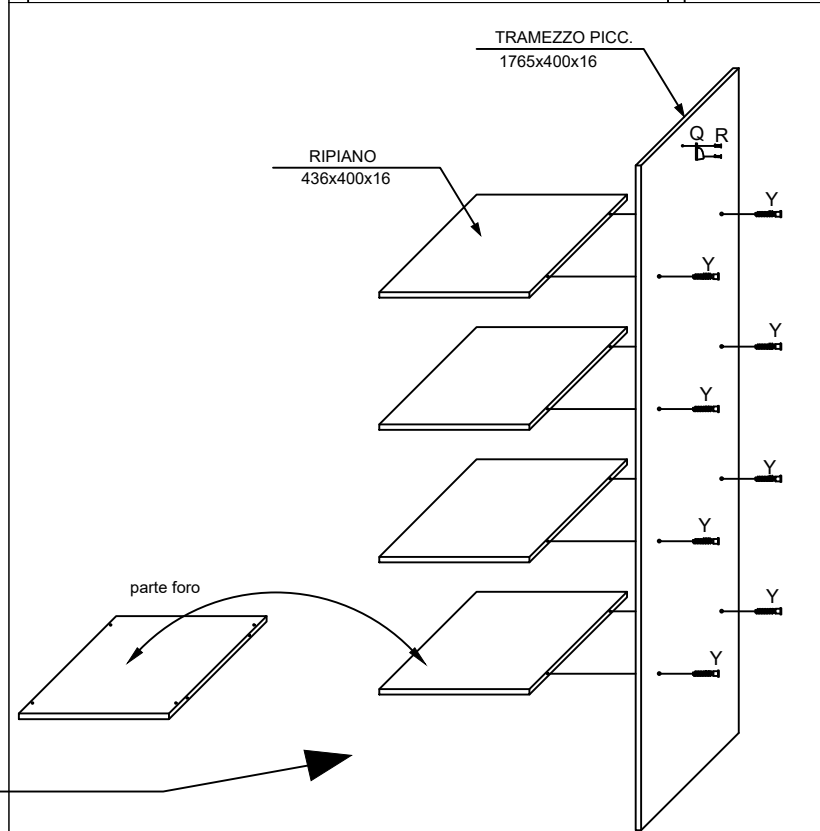
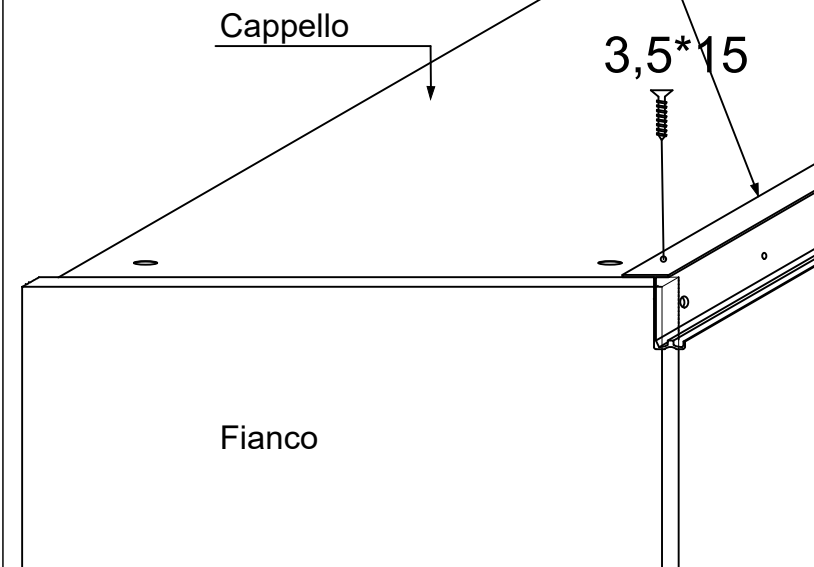





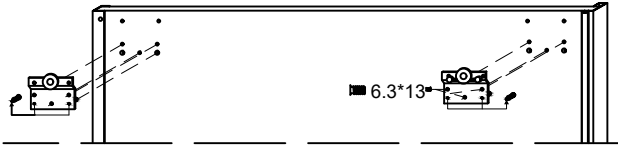



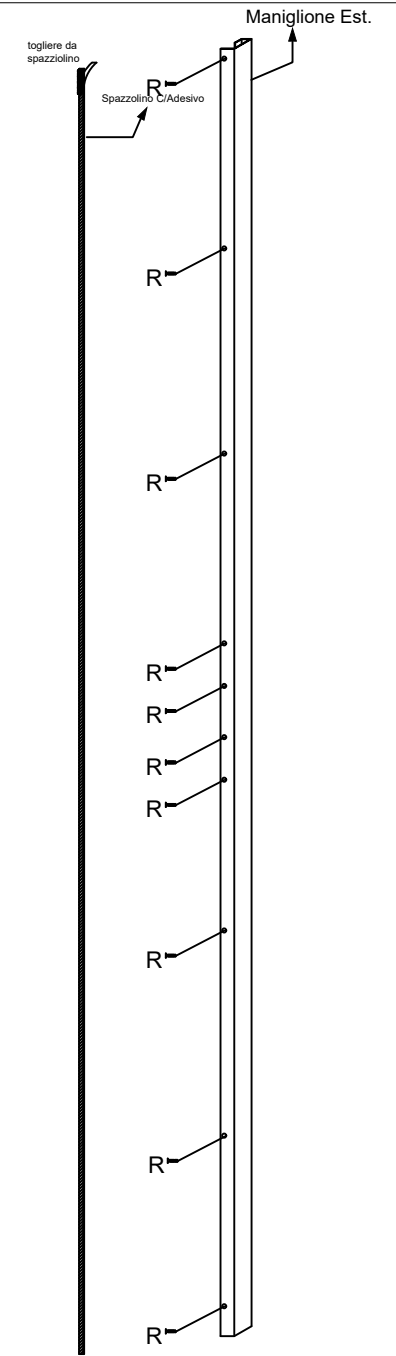
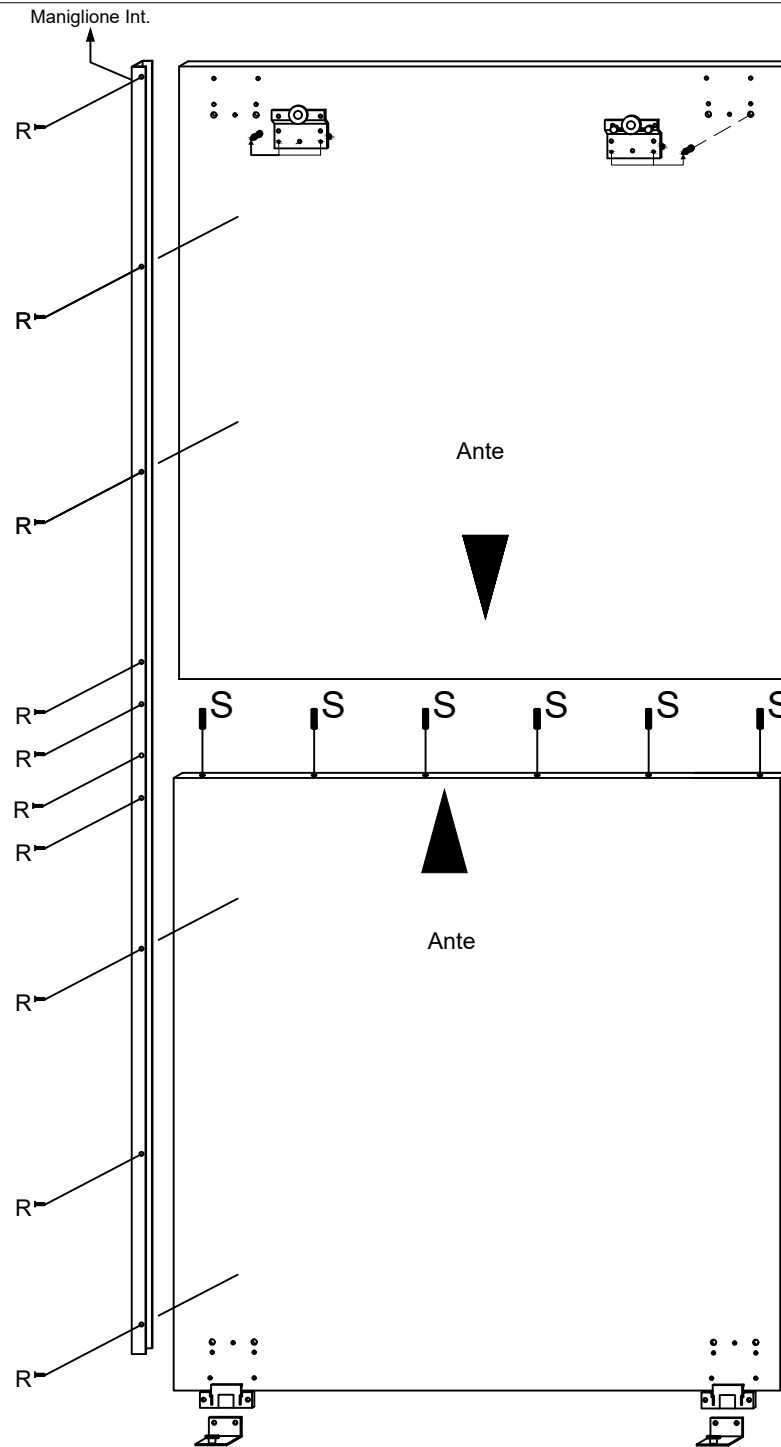
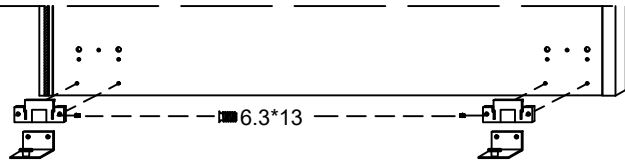
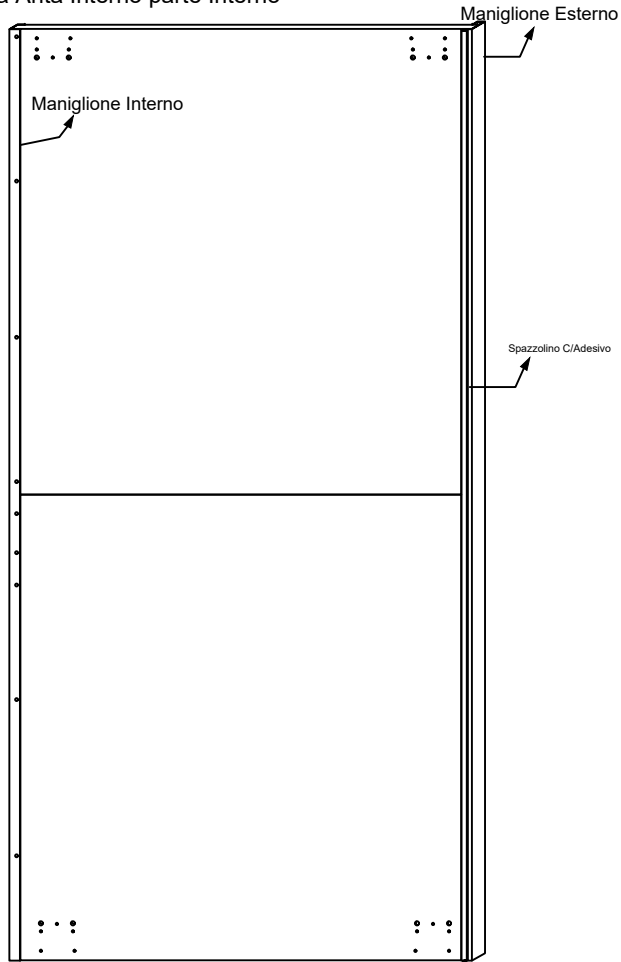





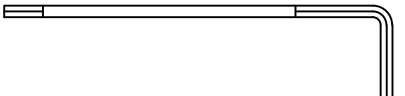







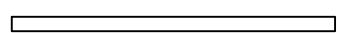

MOD. DELIZIA
Notice de montage
Assembling scheme

6

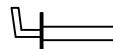

Vista Anta Interno parte Interno



A NON INCLUSE  N°6	B NON INCLUSE  N°6	M NON INCLUSE  N°6	D NON INCLUSE  N°1		
U  N°16	L 6.3*9  N°16	S D.8x30  N°32	E  N°16	Q Reggitubo  N°4	H 3*20  N°40
I  N°9	O  N°12	P  N°12	N Tappi copriforo D.10 pl. bianco  N°6	R 3.5*15  N°114	C Lastrine Ferro  N°6
Z TUBO OVALE NICH. L.1219  N°2		X 3.5*50  N°12		SPECCHIERA  N°2	
CONF.					
U x8 	L x8 	Y x8 	F x2 	Q x2 Reggitubo 	Z1 x1 TUBO OVALE NICH. L.766 

ARMADIO SCORREVOLE

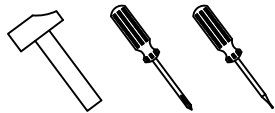

MOD. SAVANA

Notice de montage
Assembling scheme

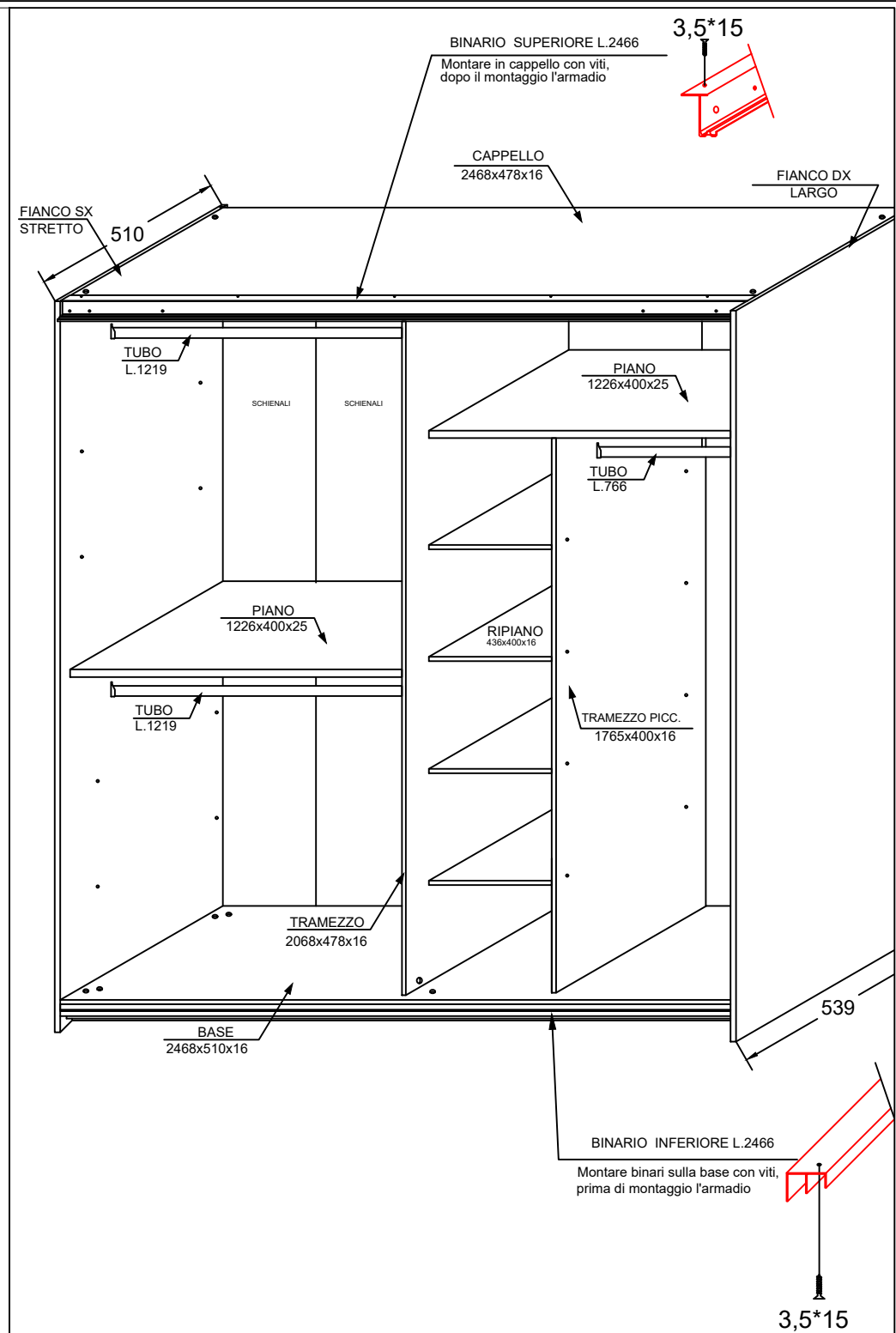

COMODINO SVETLANA ZMT.

Notice de montage
Assembling scheme

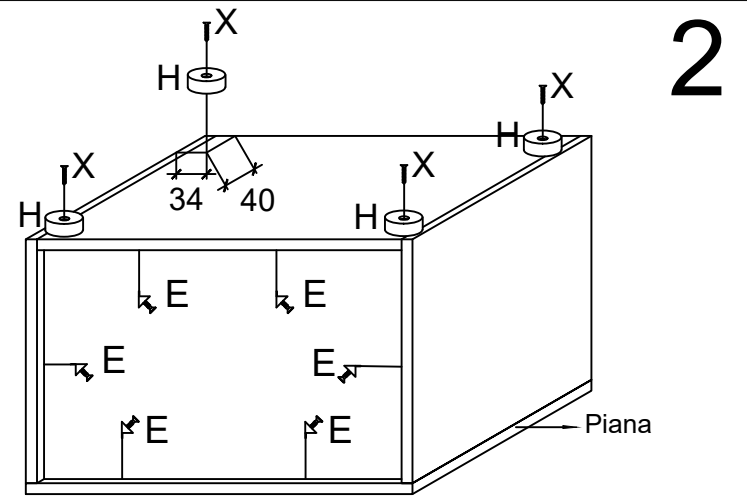
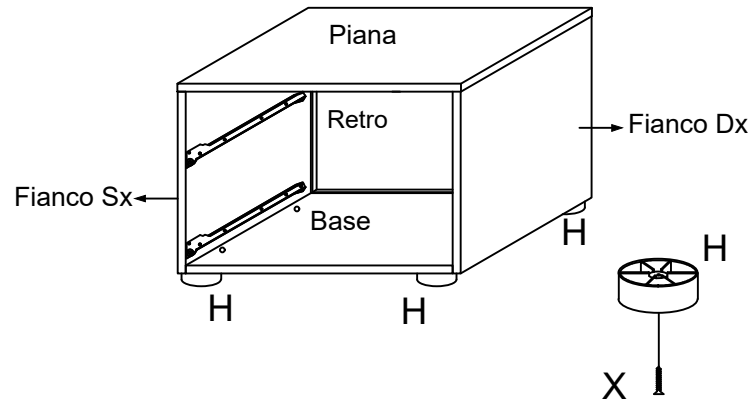
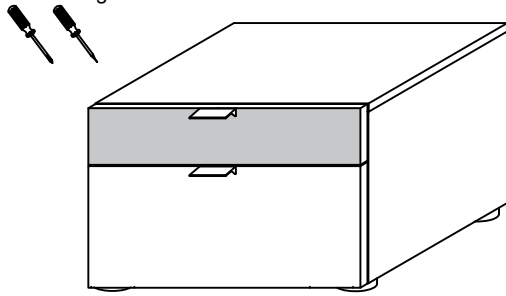

2

MANIGLIE		4MA*17	4MA*20.5
		N°2	N°2
B		Viti 3.5x15	N°12
A			N°4
C		6.3x9	N°8
P		P 15*10	N°4
O		P 15*12	N°8
Y	Paracolpo Adesivo		N°4
S			N°12
H	PIEDI		N°8
E	Fissaggio Retro-Fondin		N°16
X	Viti 3.5x30		N°4
Z	Z-L N°2		N°2 R
	Z-R N°2		N°2 L
F	Cassetto Nr°2		N°1
	Cassetto Nr°1		N°1

1

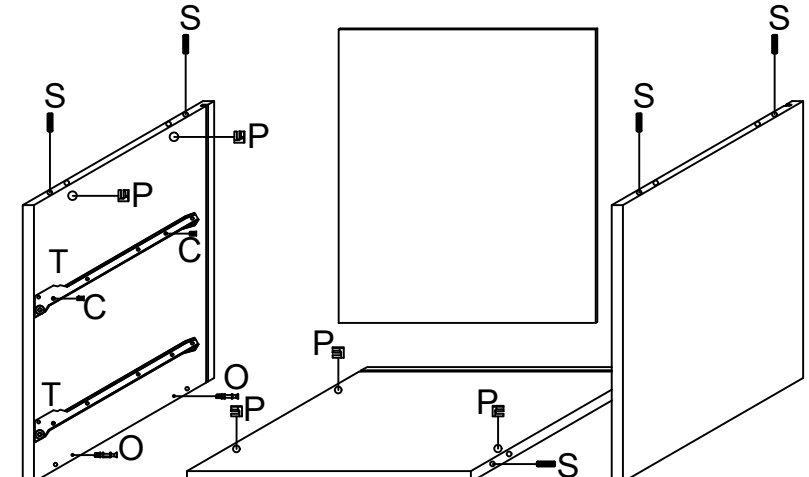
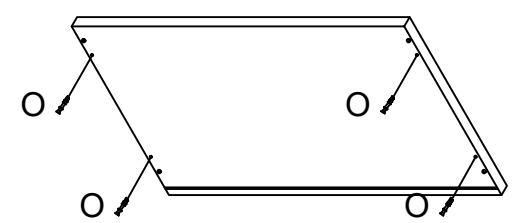
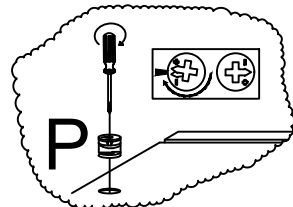

3

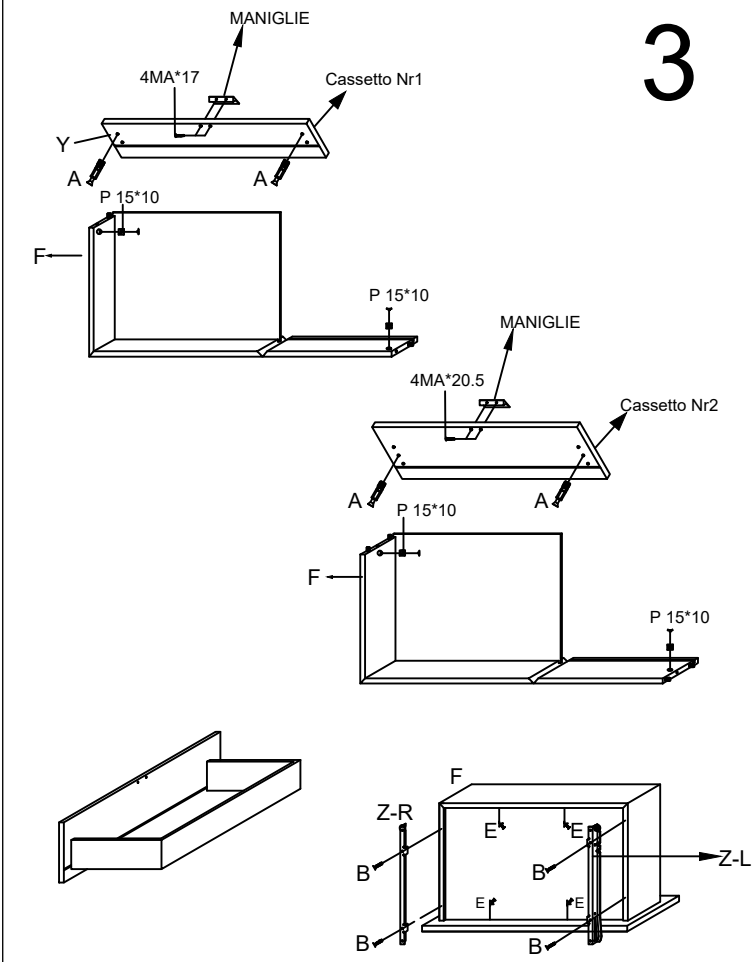

COMO SVETLANA ZMT.

Notice de montage
Assembling scheme

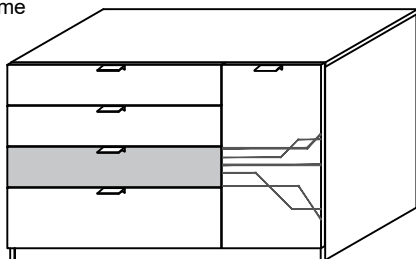

1

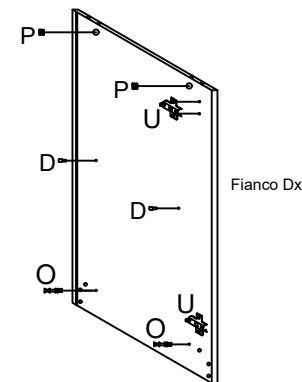
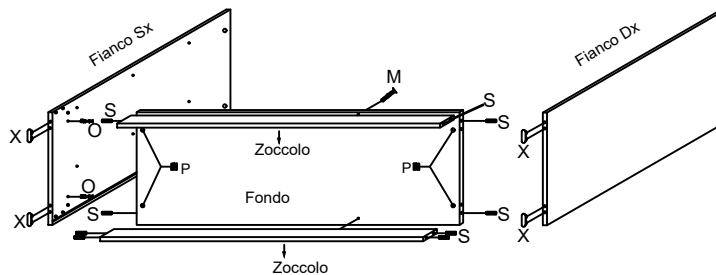

MANIGLIE		4MA*17	4MA*20.5
N°5	N°8	N°2	
B 3.5x15 N°24	A N°8		
X N°4	P 15*10 N°8		
O N°12	P N°12	C 6.3 x9 N°16	
S N°20	E N°26		
Z Z-L N°4	T N°4 R		
			N°4 L
F N°4			
U N°2	L N°2		
M 3.5x35 N°2	D N°4		

2

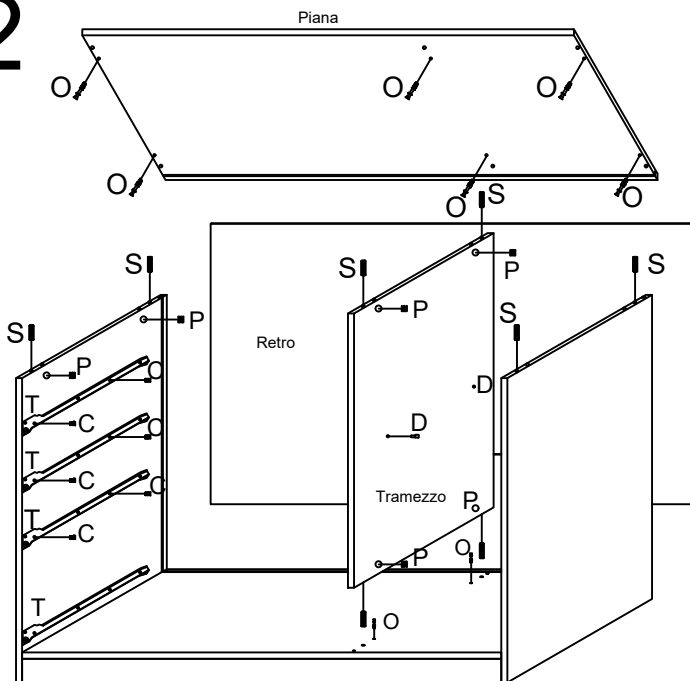

3

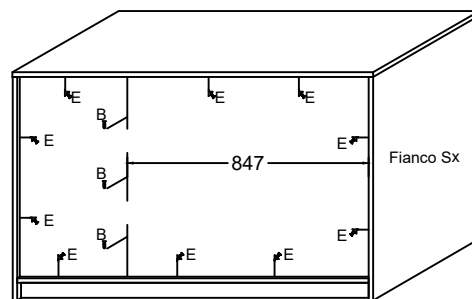

Vista Dietro

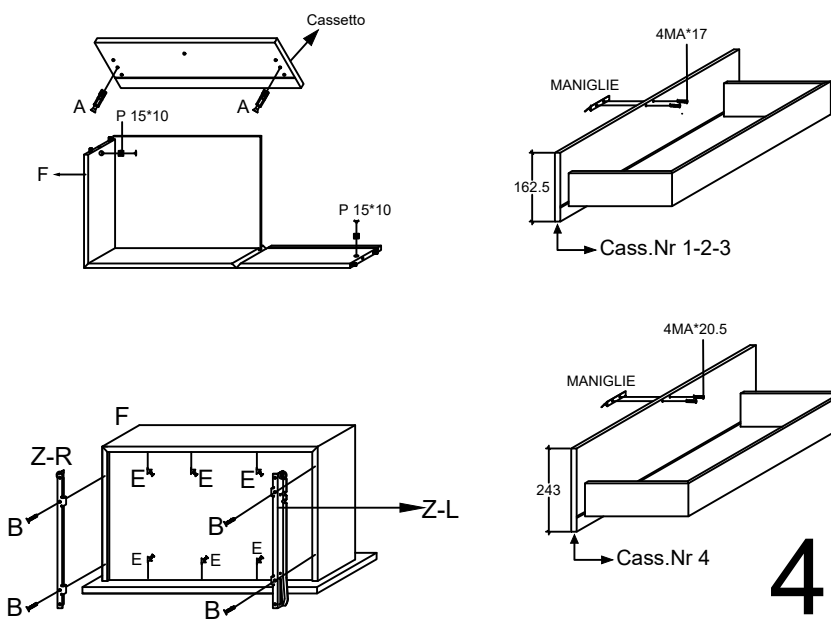

4

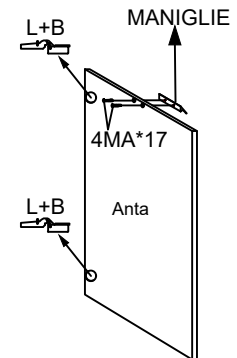
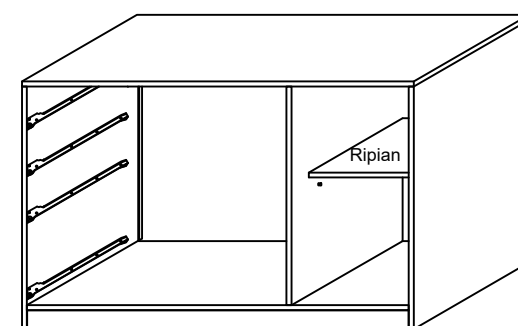

LETTO SVETLANA

Notice de montage
Assembling scheme

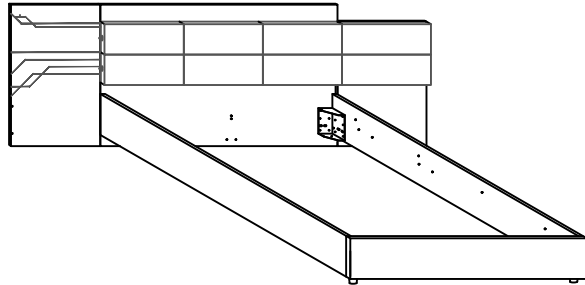

2

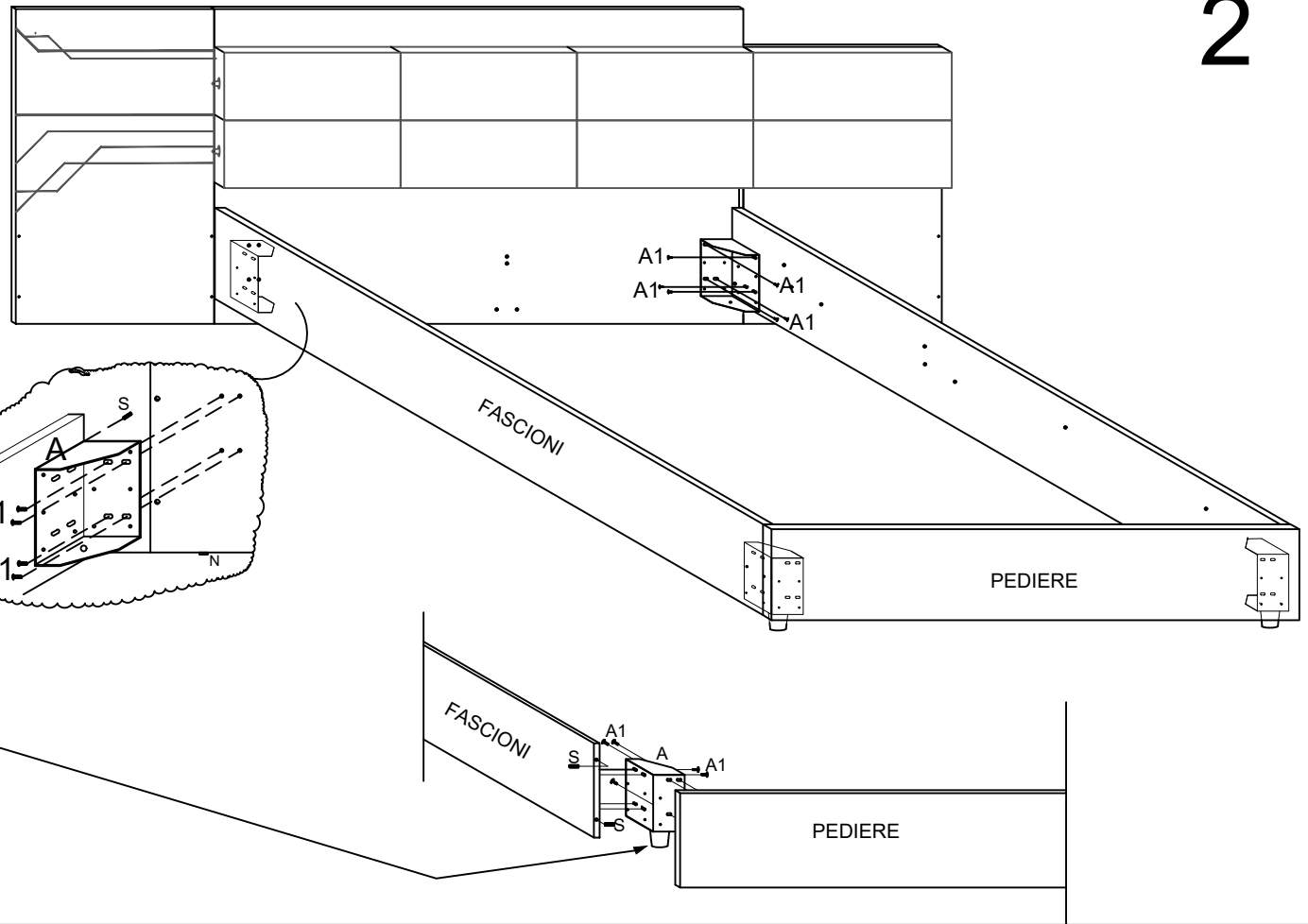

LETTO

A cubi contenitori N°4	A1 6MA*15 N°32
B Piedi plastica N°2	B1 8MA*20 N°2
S spine legno 8*30 N°8	
R 3*50 N°8	vite per fissaggio allungabile con cmd.
G ferro N°4	M 3,5*15 N°16
N FELTRINO CIADESIVO N°6	

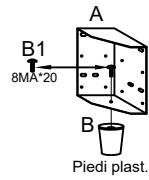

1

VISTA TESTIERE PARTE DIETRO

