

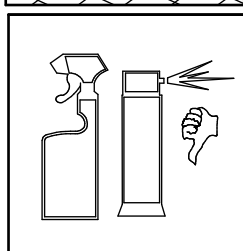

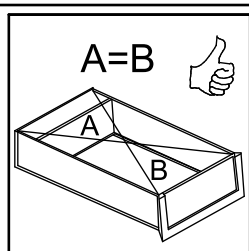

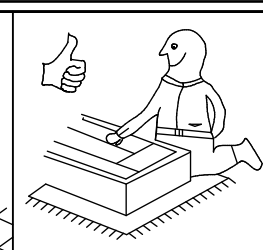

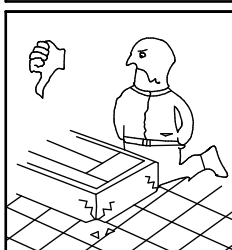

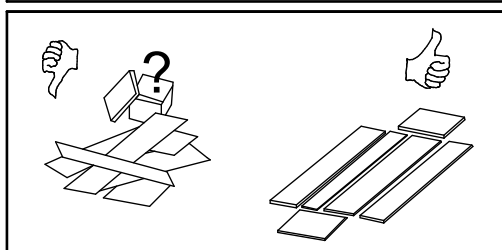
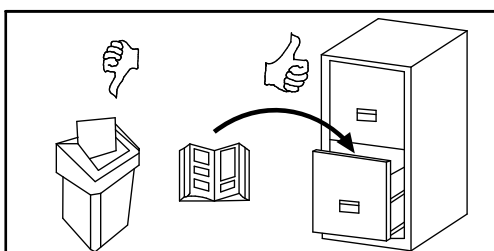
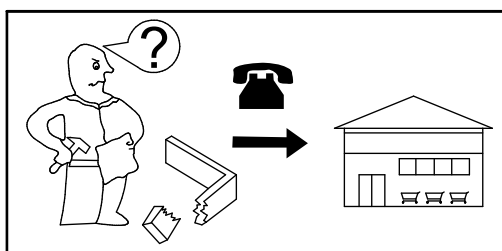
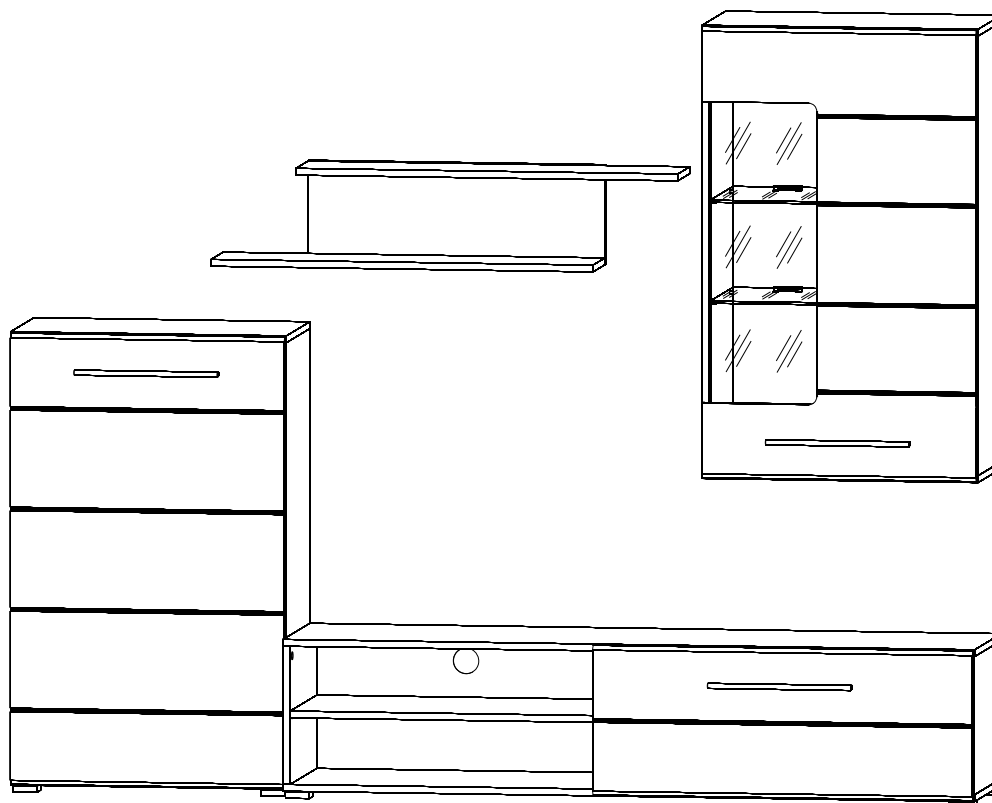
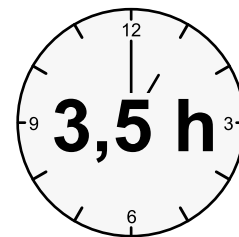
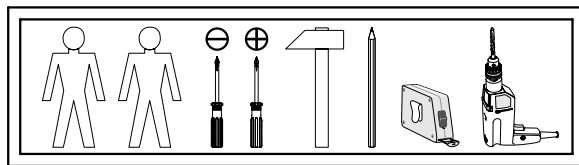
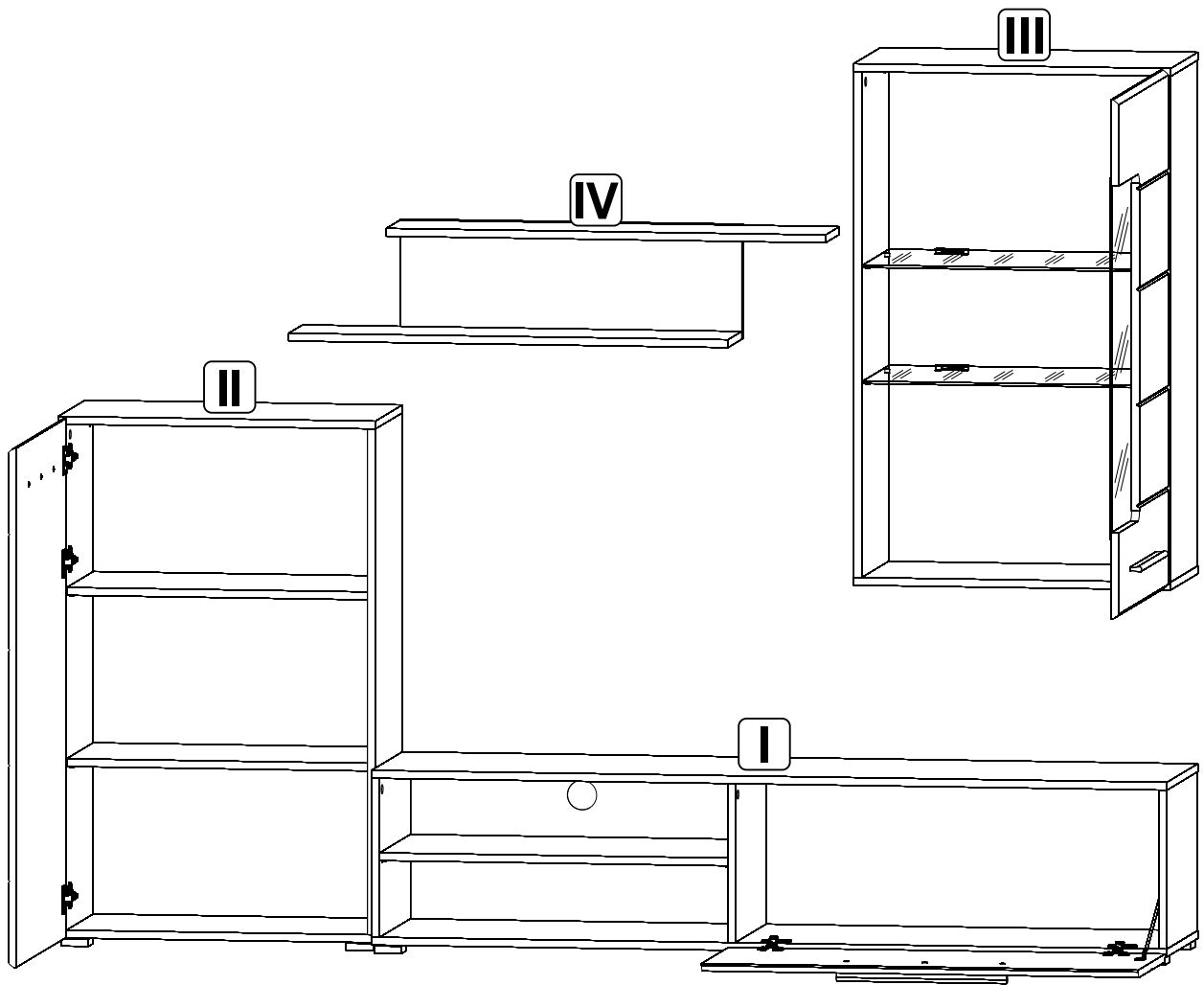
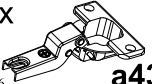
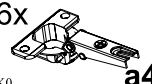
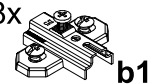



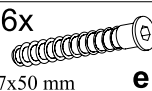
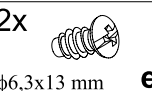
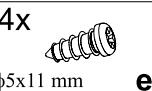
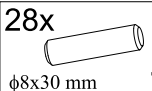

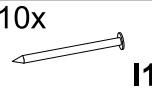
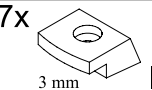

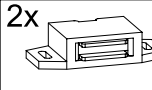

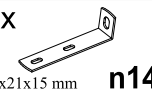

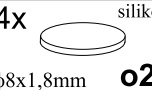
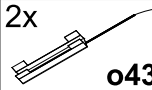

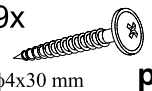
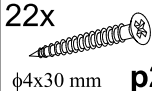

# ЛЕНА / LENA



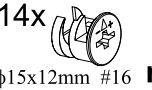
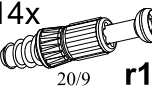

2x K16  <b>a43</b>	6x K0  <b>a44</b>	8x  <b>b19</b>	3x L 340 mm  <b>c520</b>	12x  φ5x17 mm <b>d1</b>	8x  φ5x17 mm <b>d3</b>
26x  φ7x50 mm <b>e1</b>	2x  φ6,3x13 mm <b>e2</b>	4x  φ5x11 mm <b>e4</b>	28x  φ8x30 mm <b>f1</b>	2x  <b>g2</b>	9x  56x56x20 mm <b>k52</b>
110x  <b>l1</b>	7x  3 mm <b>l3</b>	1x  <b>m48</b>	2x  <b>n2</b>	2x  50x12x1,5 mm <b>n3</b>	2x  <b>n10</b>
1x  81x21x15 mm <b>n14</b>	2x  <b>n122/1</b>	4x silikon  φ8x1,8mm <b>o21</b>	2x  <b>o43/1</b>	1x  <b>o43/6</b>	
4x  φ3,5x13 mm <b>p1</b>	6x  φ3,5x13 mm <b>p5</b>	9x  φ4x30 mm <b>p9</b>	22x  φ4x30 mm <b>p21</b>	16x  φ3,5x15 mm <b>p51</b>	7x  φ3x16 mm <b>p52</b>
4x  φ3x10 mm <b>p400</b>	14x  φ15x12mm #16 <b>r1</b>	14x  20/9 <b>r16</b>	4x  <b>s1</b>	12x  ø16 <b>s2</b>	1x  <b>z1</b>

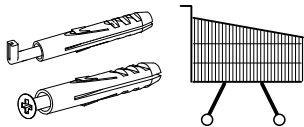

**I** Тумба PTB / Szafka RTV

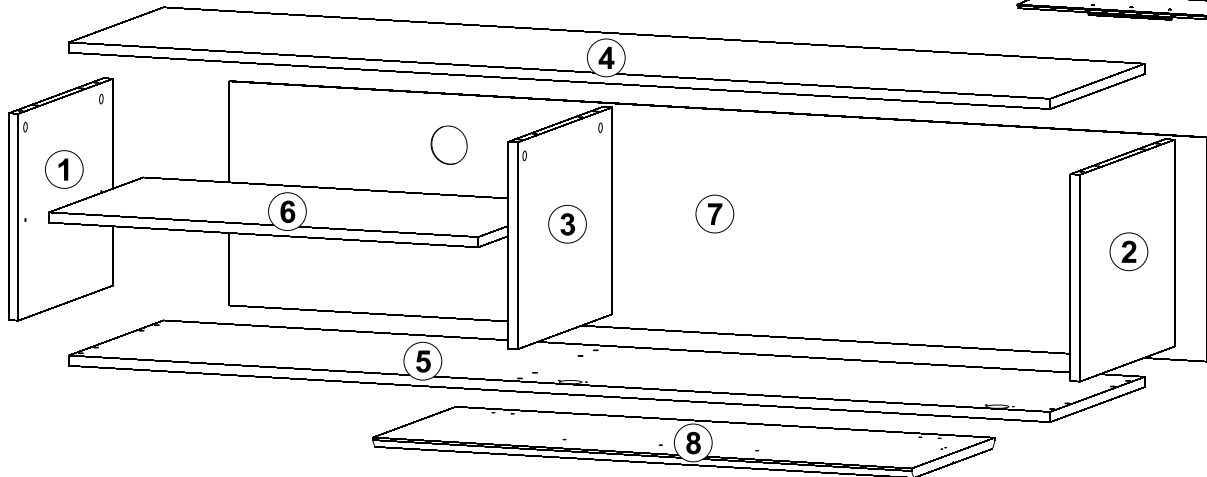
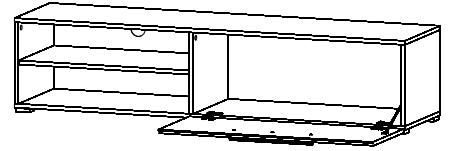

A	B	C	D	A	B	C	D		
1	ML1-105	323	400	1/3	5	ML1-205	1630	400	1/3
2	ML1-106	323	400	1/3	6	ML1-302	713	398	1/3
3	ML1-107	323	400	1/3	7	ML1-903	1624	350	1/3
4	ML1-204	1630	400	1/3	8	ML1-002-01	895	350	3/3



**1** §2

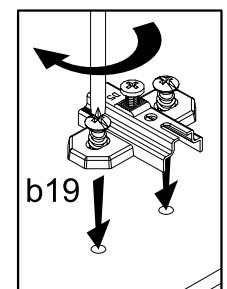
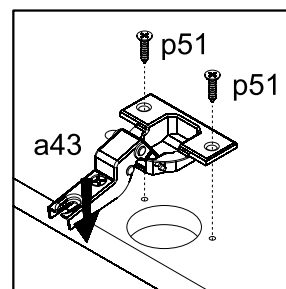
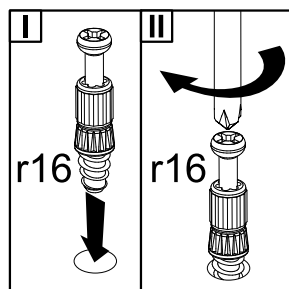
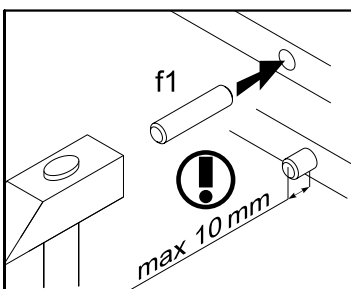
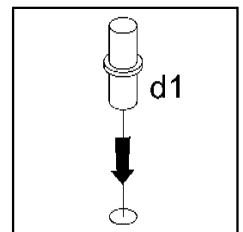
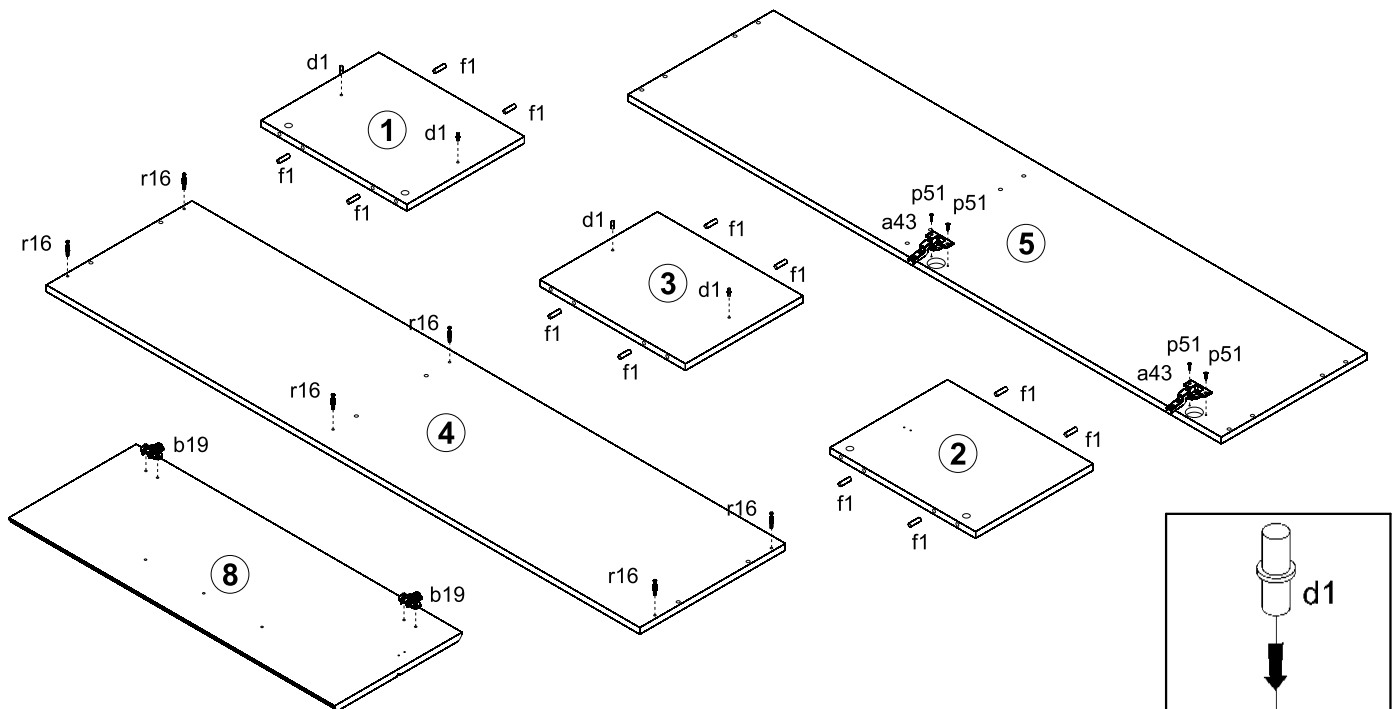
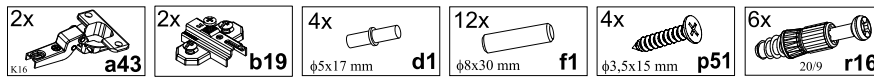

# 2

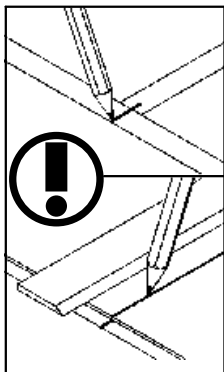
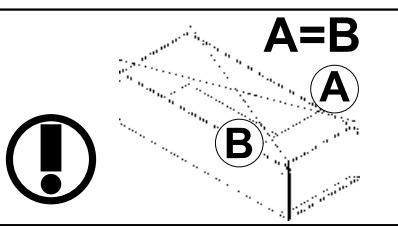
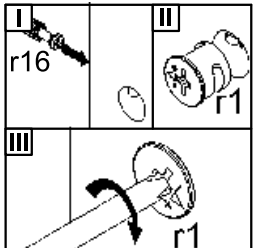
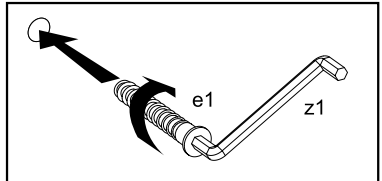
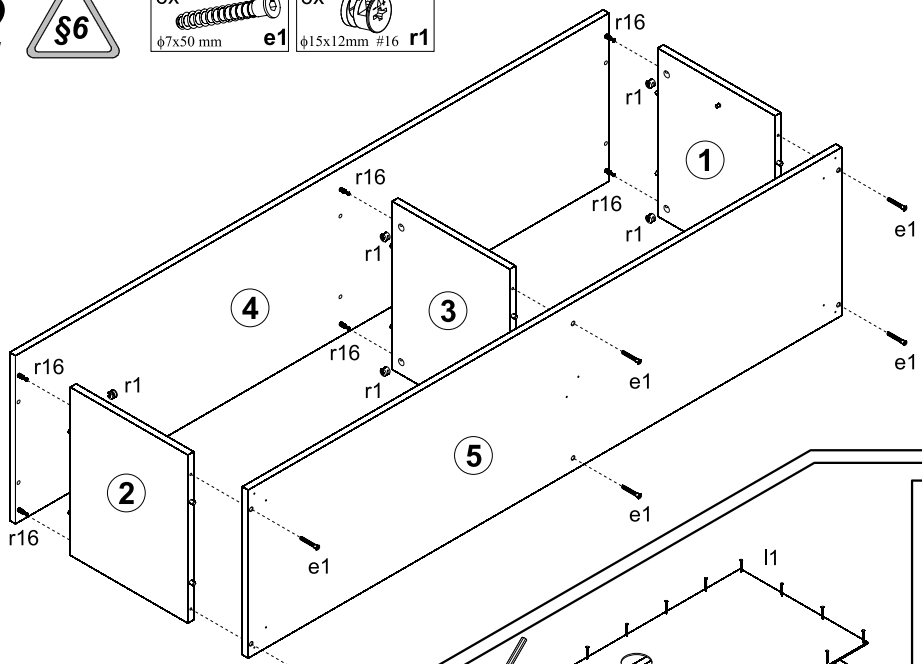
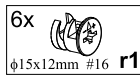
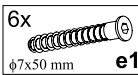

# 3

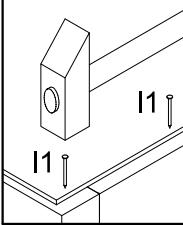
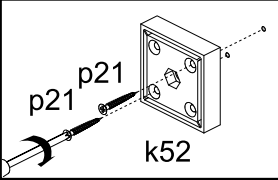
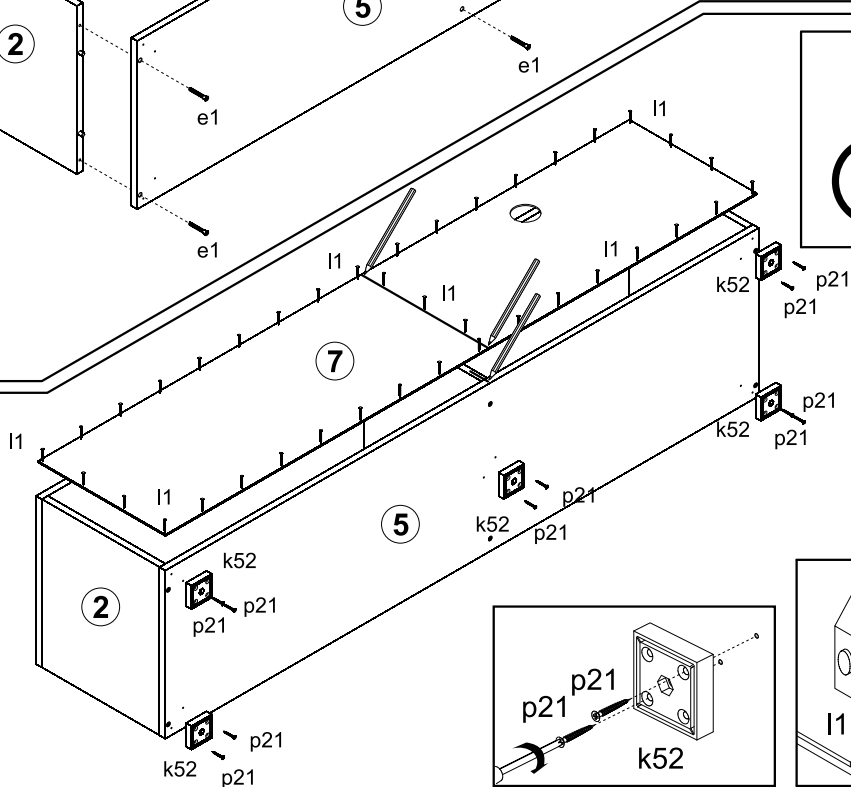
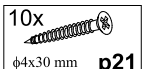
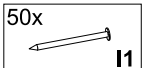
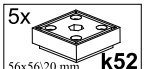

# 4

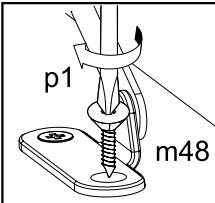
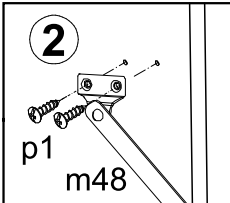
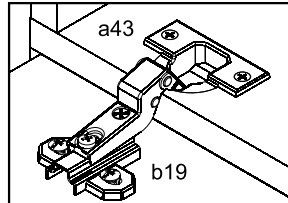
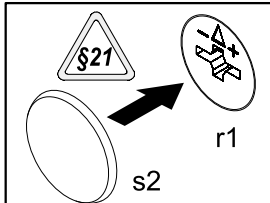
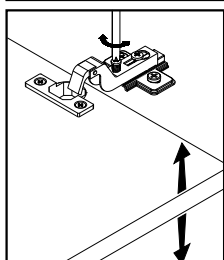
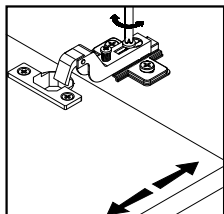
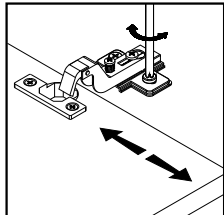
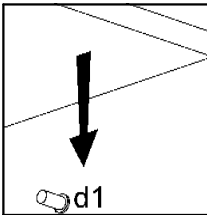
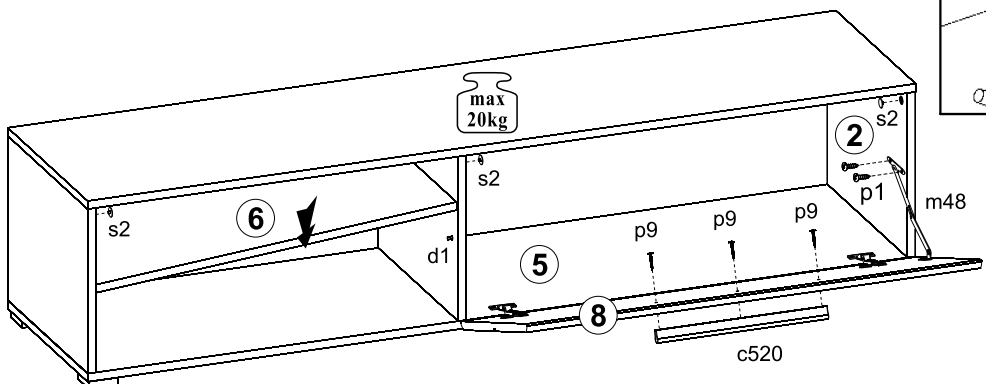

**II** Пенал / Regat

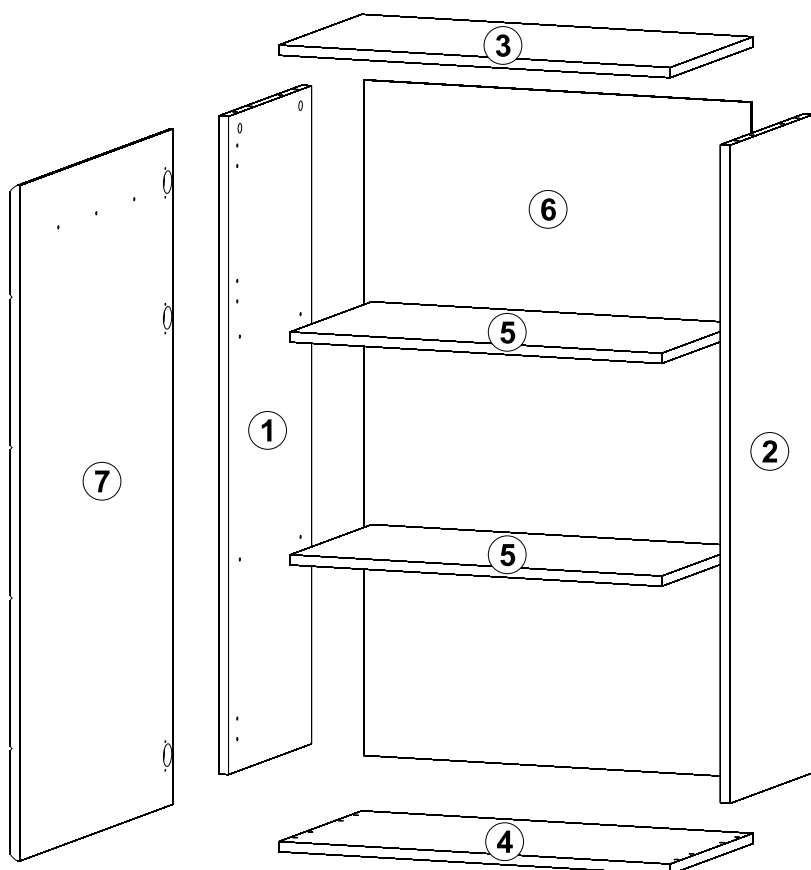
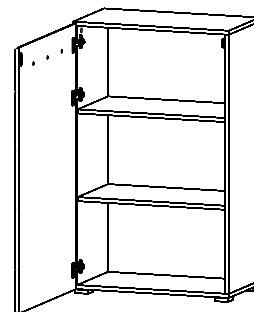

A	B	C	D
1	ML1-101	1028	350 2/3
2	ML1-102	1028	350 2/3
3	ML1-201	650	350 2/3
4	ML1-202	650	350 2/3
5	ML1-304	617	344 2/3
6	ML1-901	1055	644 3/3
7	ML1-001-01	645	1055 3/3

**5**

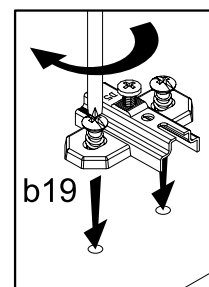
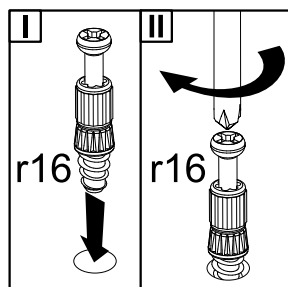
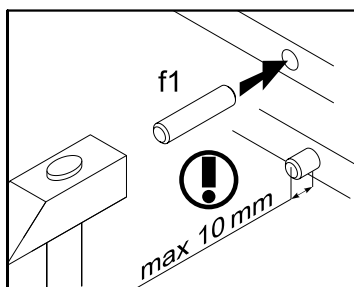
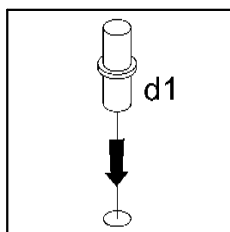
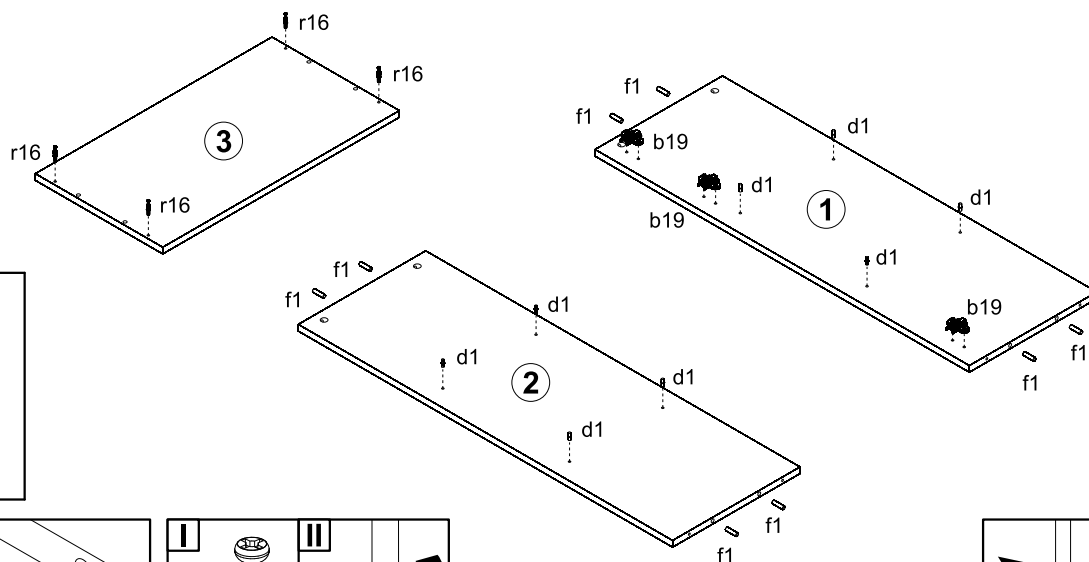
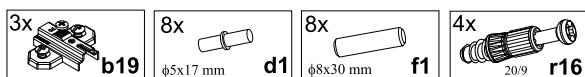

# 6

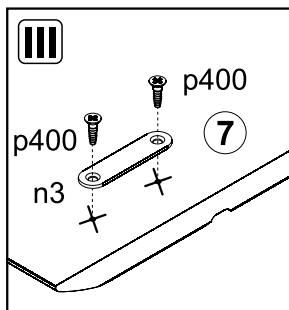
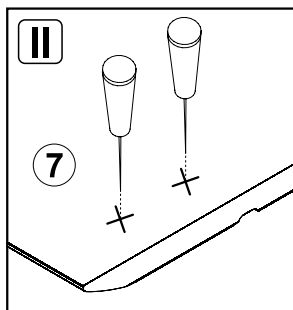
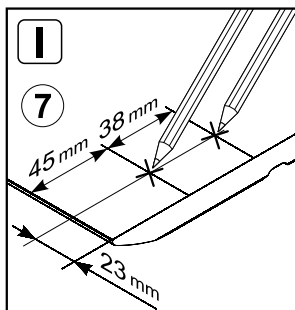
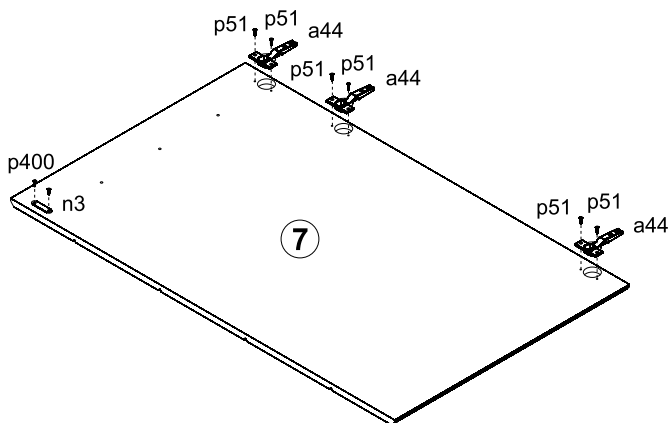
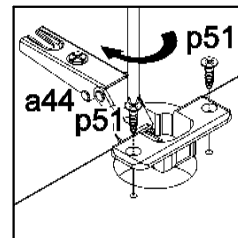
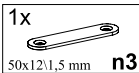
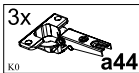

# 7

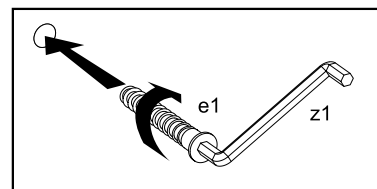
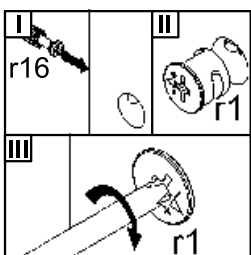
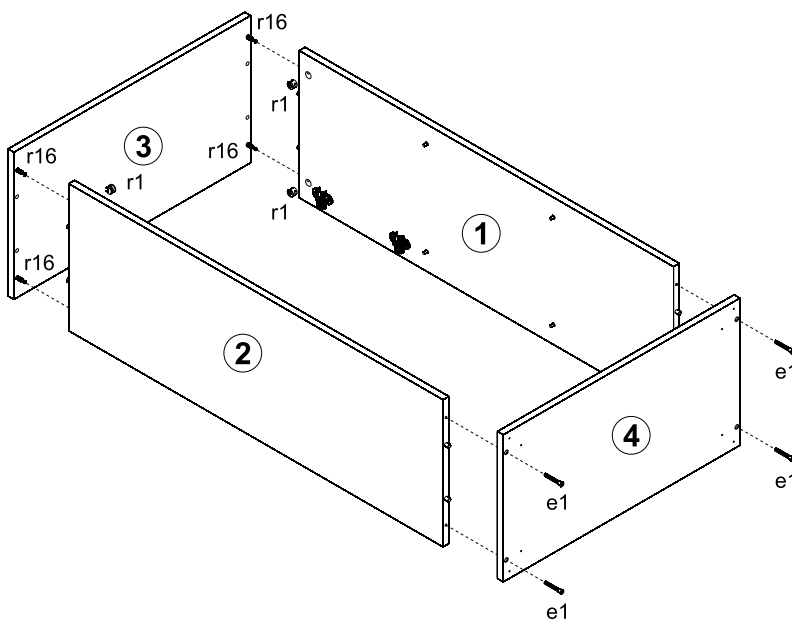
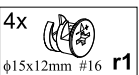
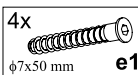

# 8

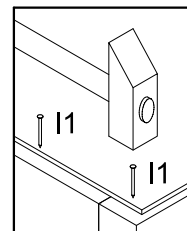
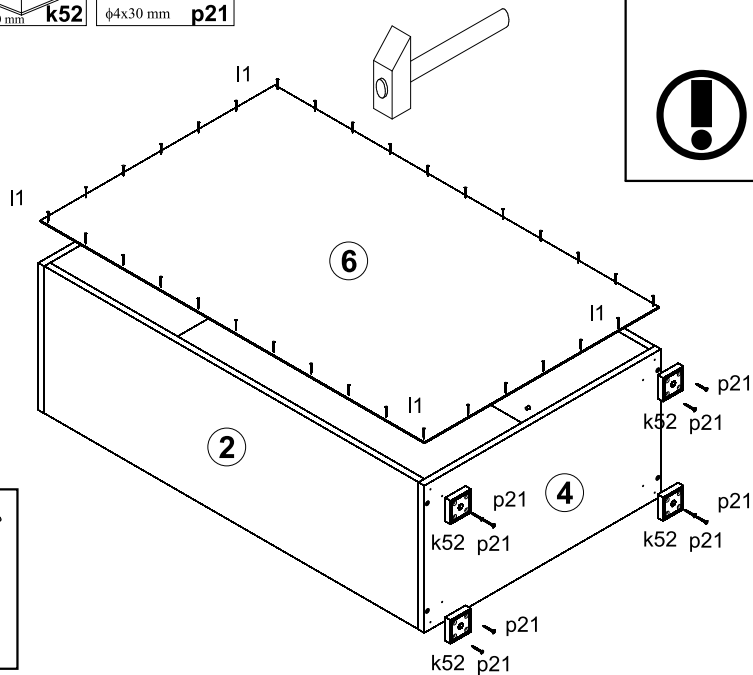
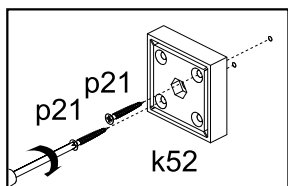
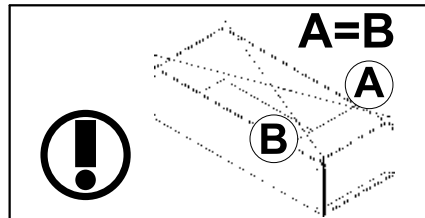
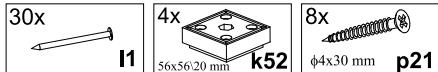

# 9

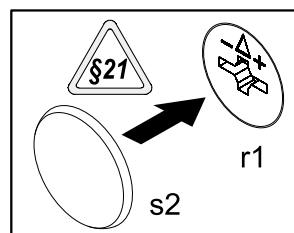
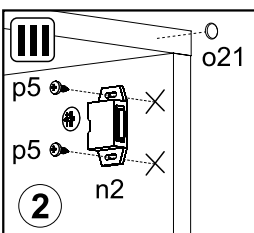
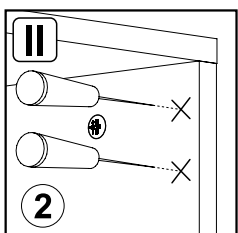
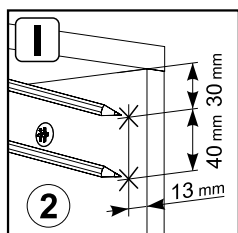
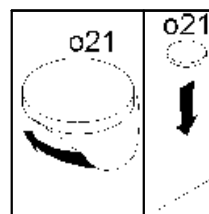
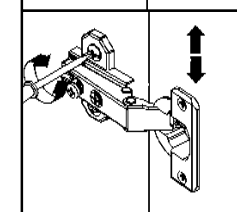
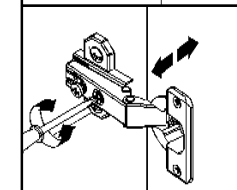
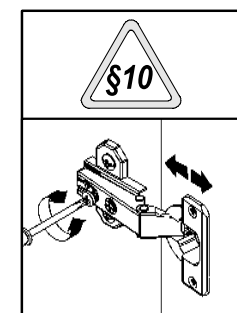
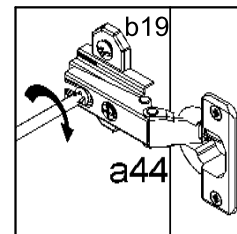
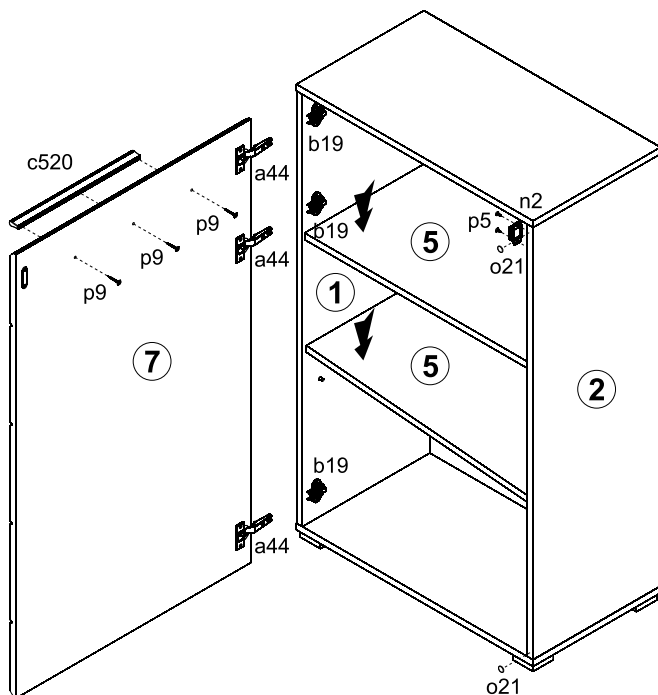
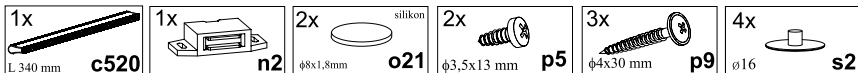



Вітрина навісна права / Витрина навесная правая / Witryna wisząca prawa

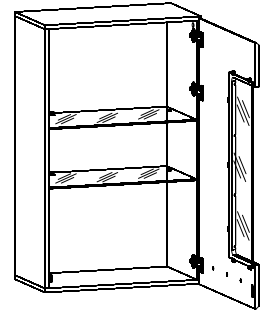
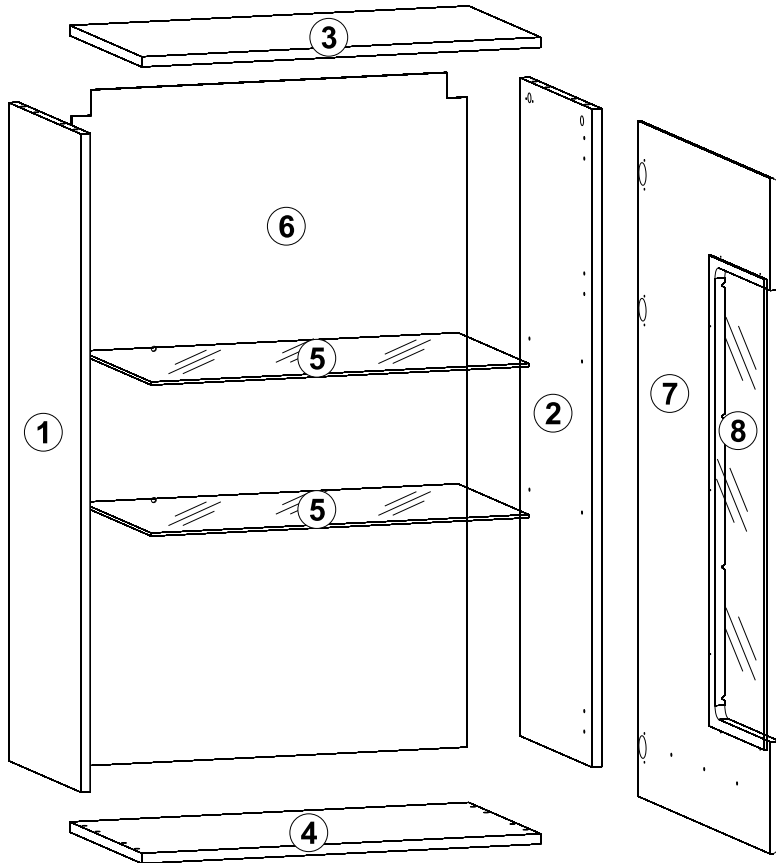

A	B	C	D	
1	ML1-103	1028	350	2/3
2	ML1-104	1028	350	2/3
3	ML1-201	650	350	2/3
4	ML1-203	650	350	2/3
5	ML1-301	615	329	2/3
6	ML1-902	1055	644	3/3
7	ML1-003-01	645	1055	3/3
8	ML1-501	735	270	3/3

10

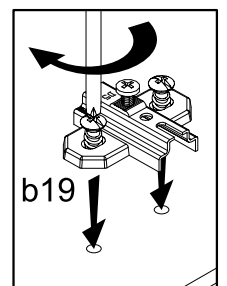
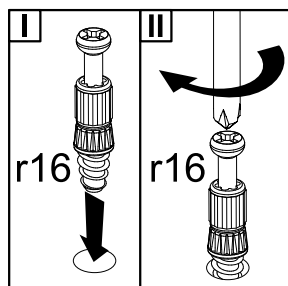
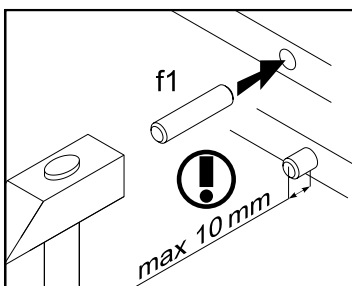
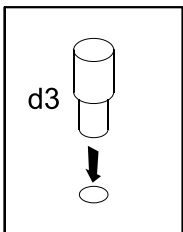
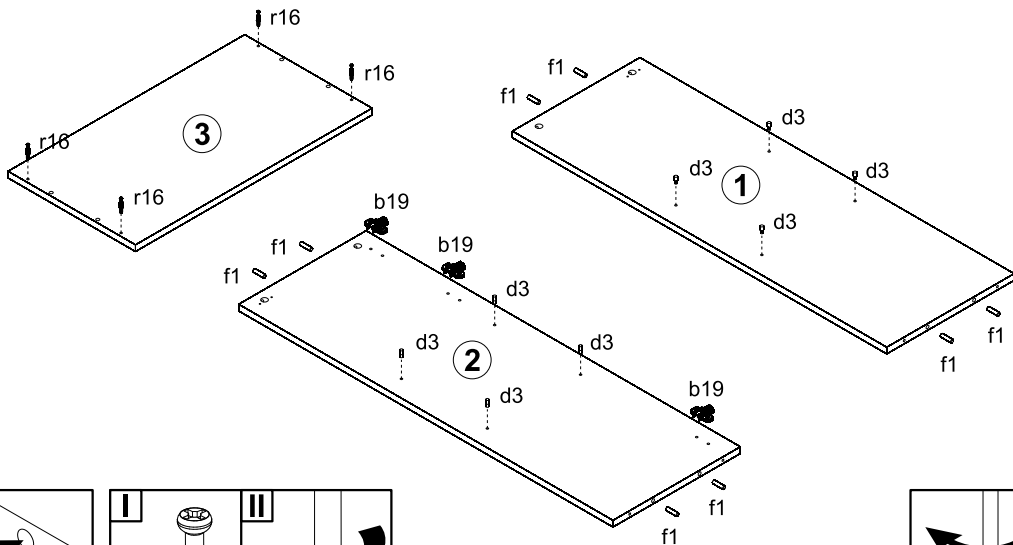
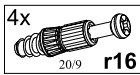
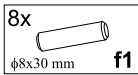
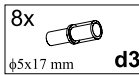
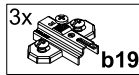



# 11

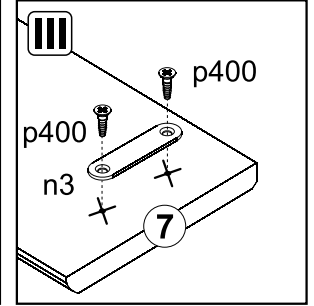
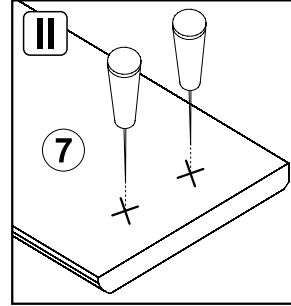
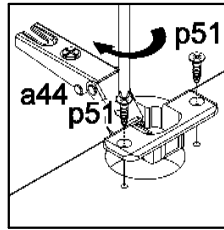
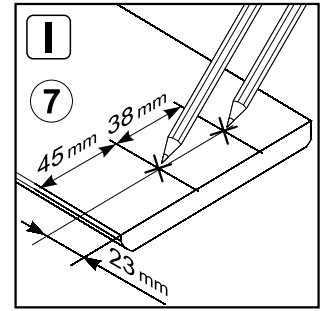
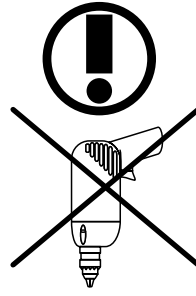
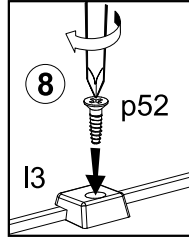
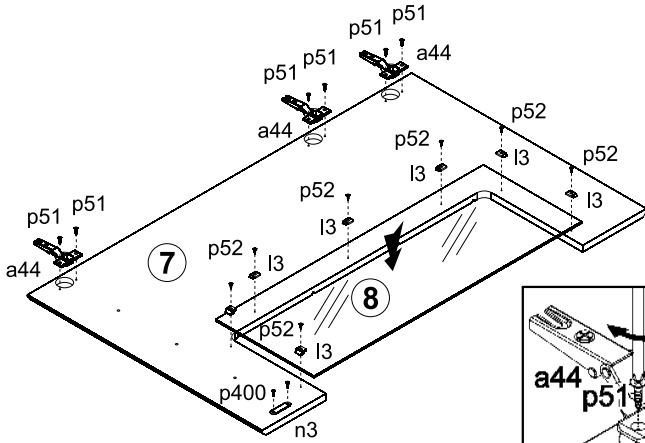
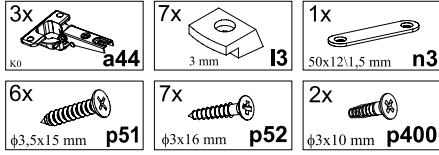

# 12

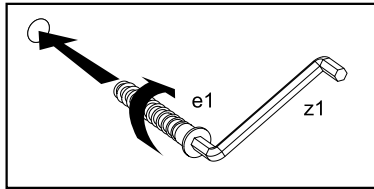
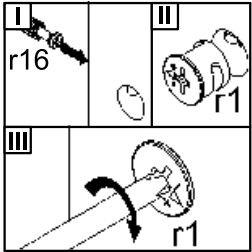
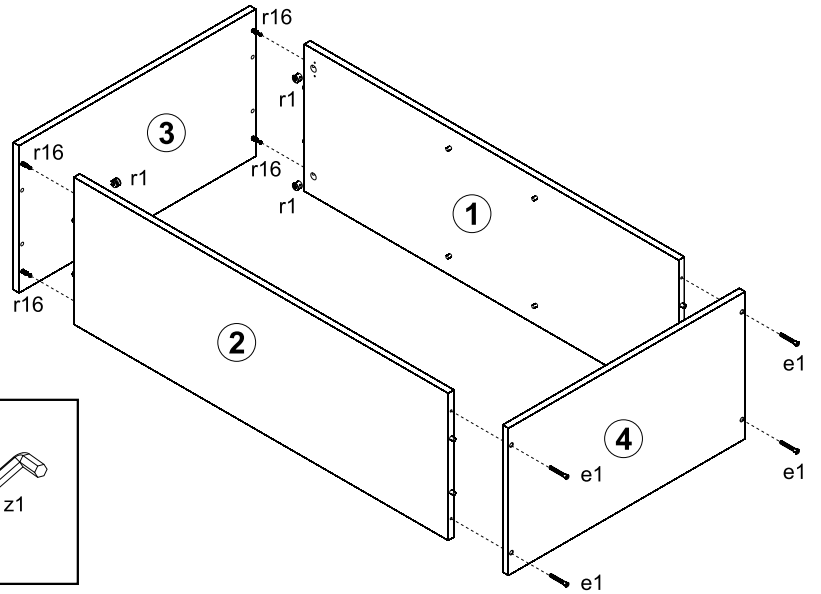
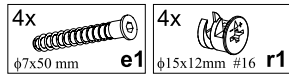

# 13

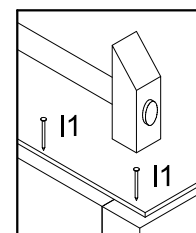
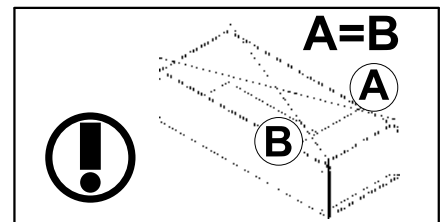
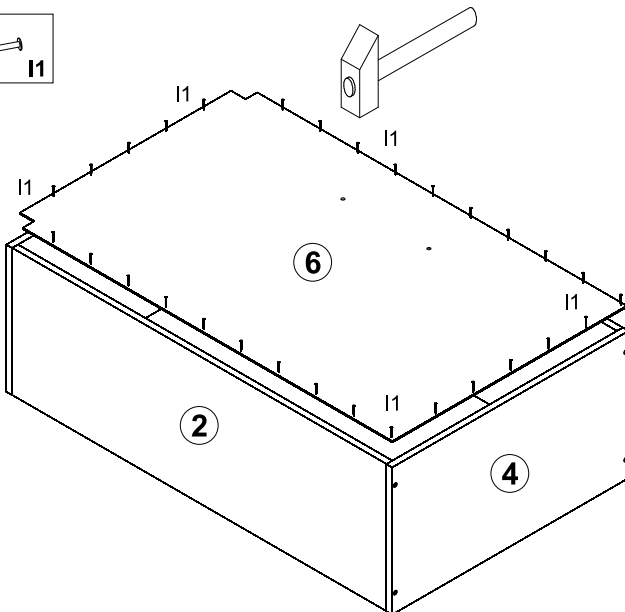

# 14

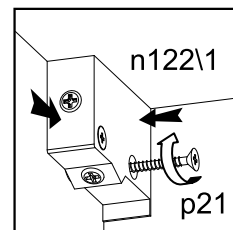
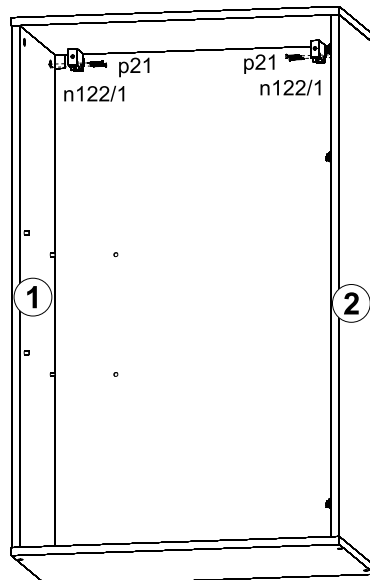
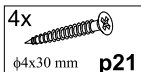

# 15

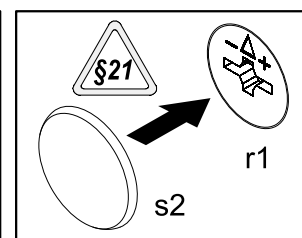
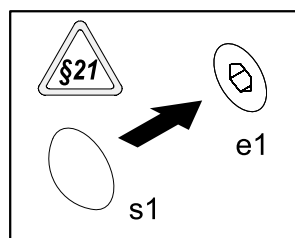
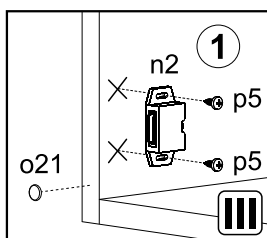
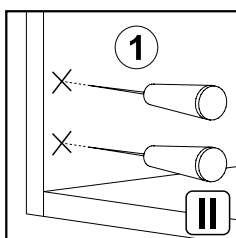
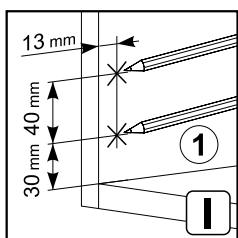
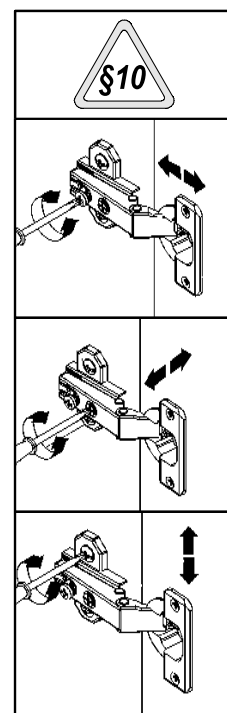
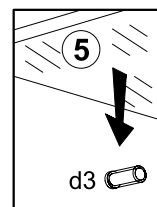
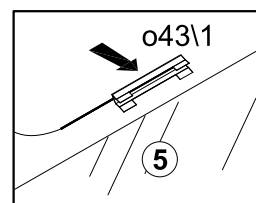
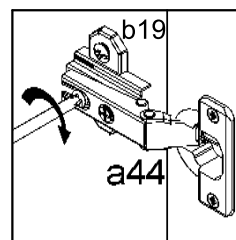
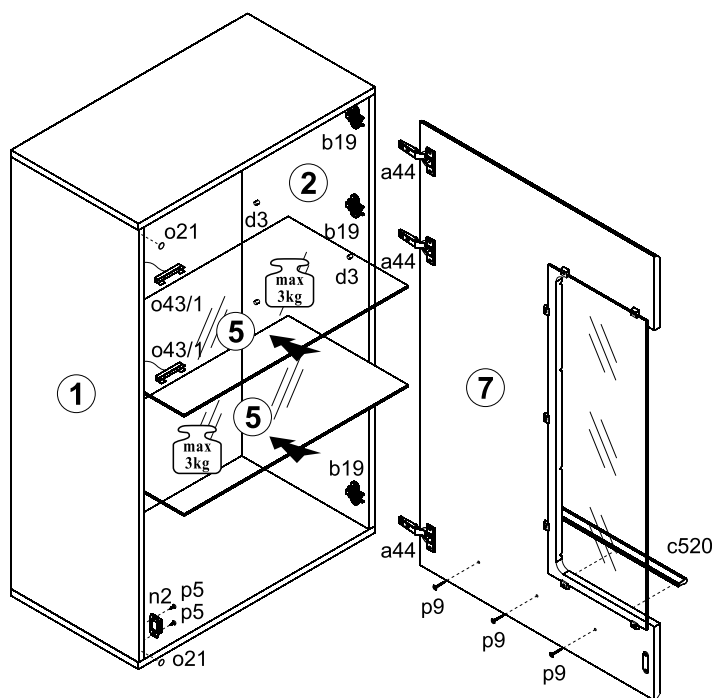
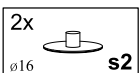
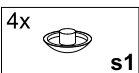
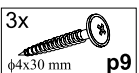
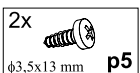
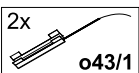
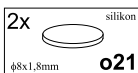
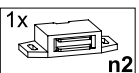
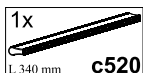

# IV Полиця / Полка / Półka

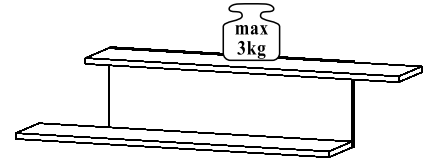
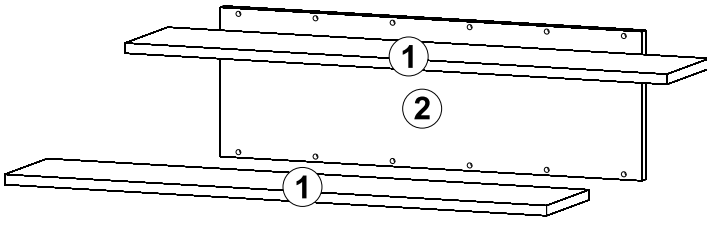

A	B	C	D
1	ML1-303	900	180
2	ML1-401	700	233

## 16

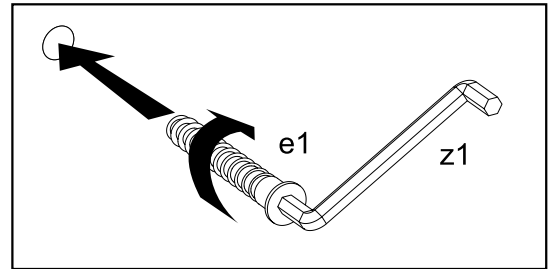
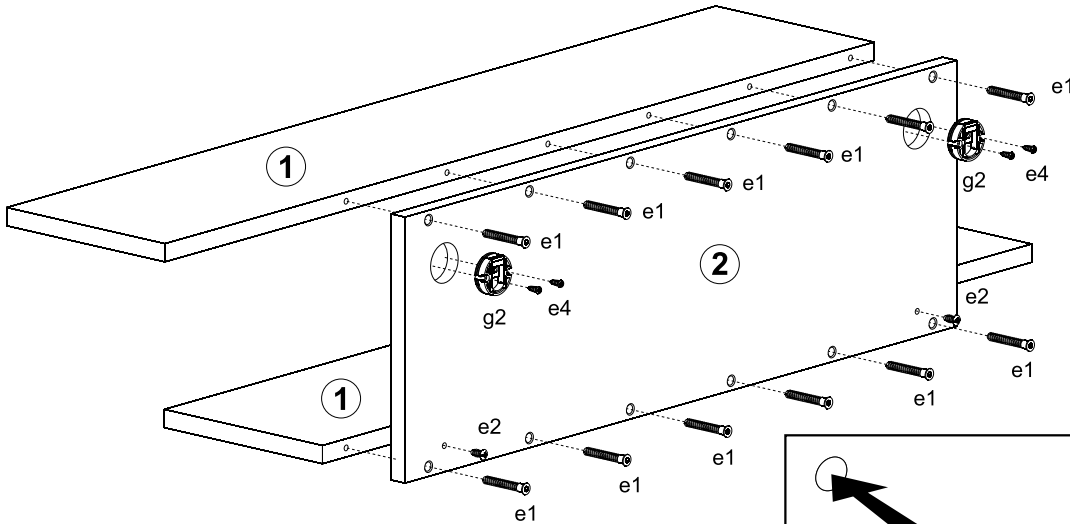
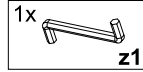
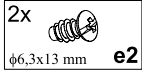

## 17

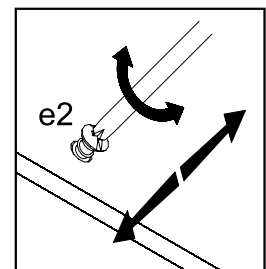
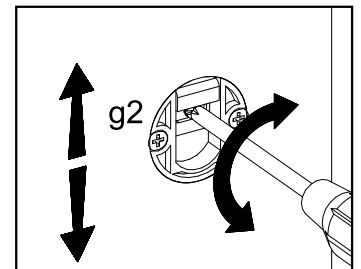
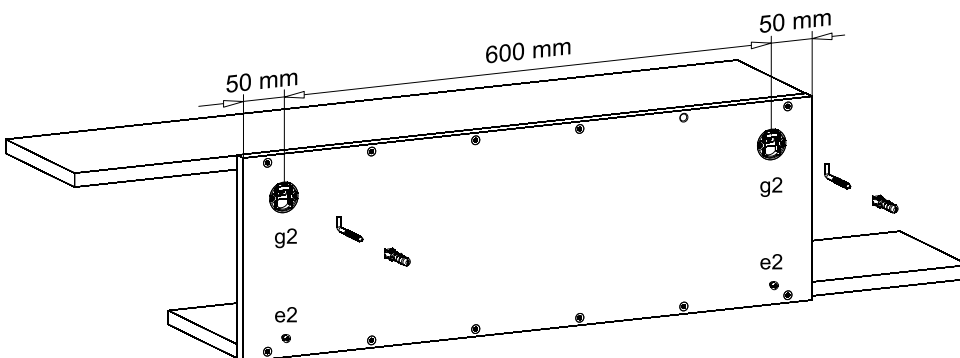
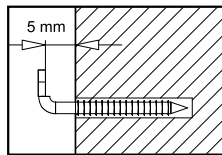
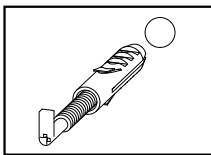
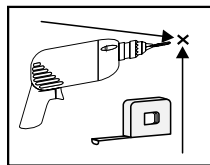
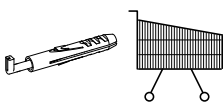

# 18

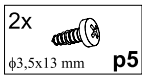
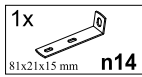
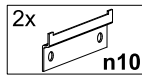

25 mm 64 mm

64 mm 25 mm

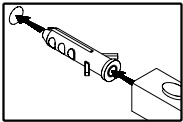
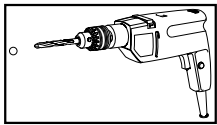
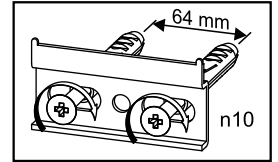
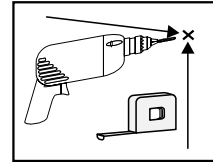

n14

