



Schita de montaj Corp inferior 600 1 usa ,1 serar



	Denumire	um	cod
	Eurosurub 7*50-	16 buc	C1
	Surub cap inecat 3,5*16	-28 buc	C2
	Surub maner m4*40mm	-2 buc	C3
	Surub cap inecat 3,5*30	-2 buc	C4
	Balama usa aplicata -	2 buc	C5
	Picior plastic reglabil	- 4 buc	C6
	Maner metalic	-2 buc	C7
	Cui 1,8x30-	20 buc	C8
	Suport polita	-4 buc	C9
	Glisiera sertar		C10



Lista piese:

Jos cod j -600*450-1 buc

Sus cod s-568*80-2buc

Laterală cod l- 650*450- buc

Raft cod rf:568*430-1 buc

front cod um 497*597*1 buc

Front sert cod ff 160*597-1 buc

Spate pfl cod pfl:595*665-1 buc

Spate sertar pfl :535x395-a1 buc

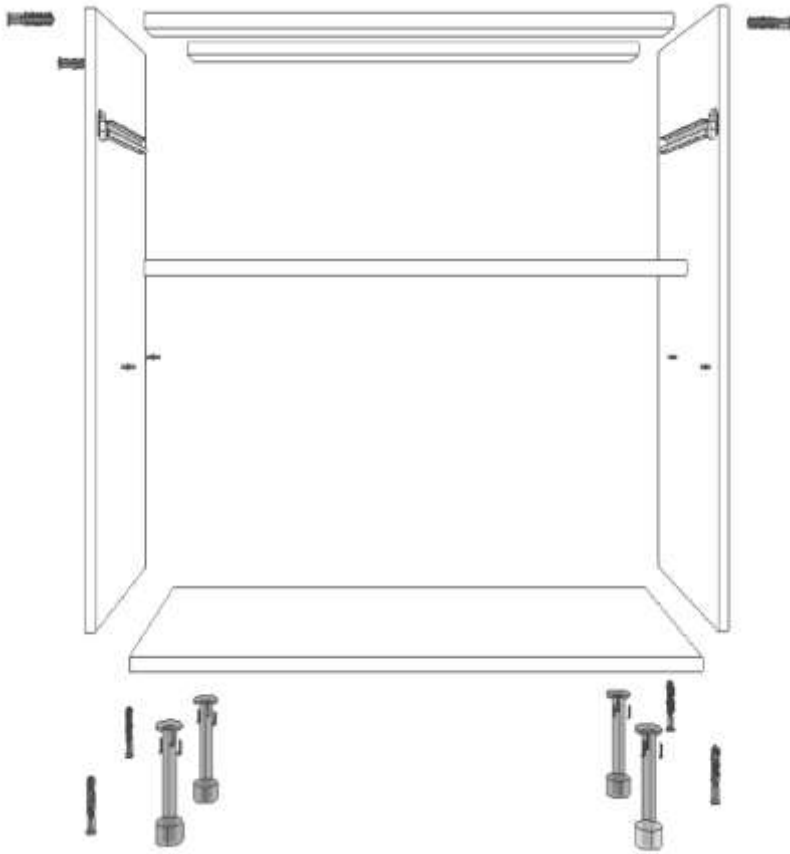

 **CB Furniture**



Schita montaj masca chiuveta 800 mm



Eurosurub 7*50 c1-8 buc



Surub cap inecat 3,5*16 c2-28 buc



Surub maner m4*25 mm c3-4 buc



Surub cap inecat 3,5*30 c4-4 buc



picior plastic –c6-4 buc



Maner metalic –c7-2 buc



Balama usa aplicata – c5- 4 buc



Lista piese :

jos cod j -800*450-1 buc

Sus cod sp -768*80-1 buc

Lateral cod lm-650*450-2 buc

Front Fals FF 797*160*1 buc

Front-cod um-497*397*2 buc

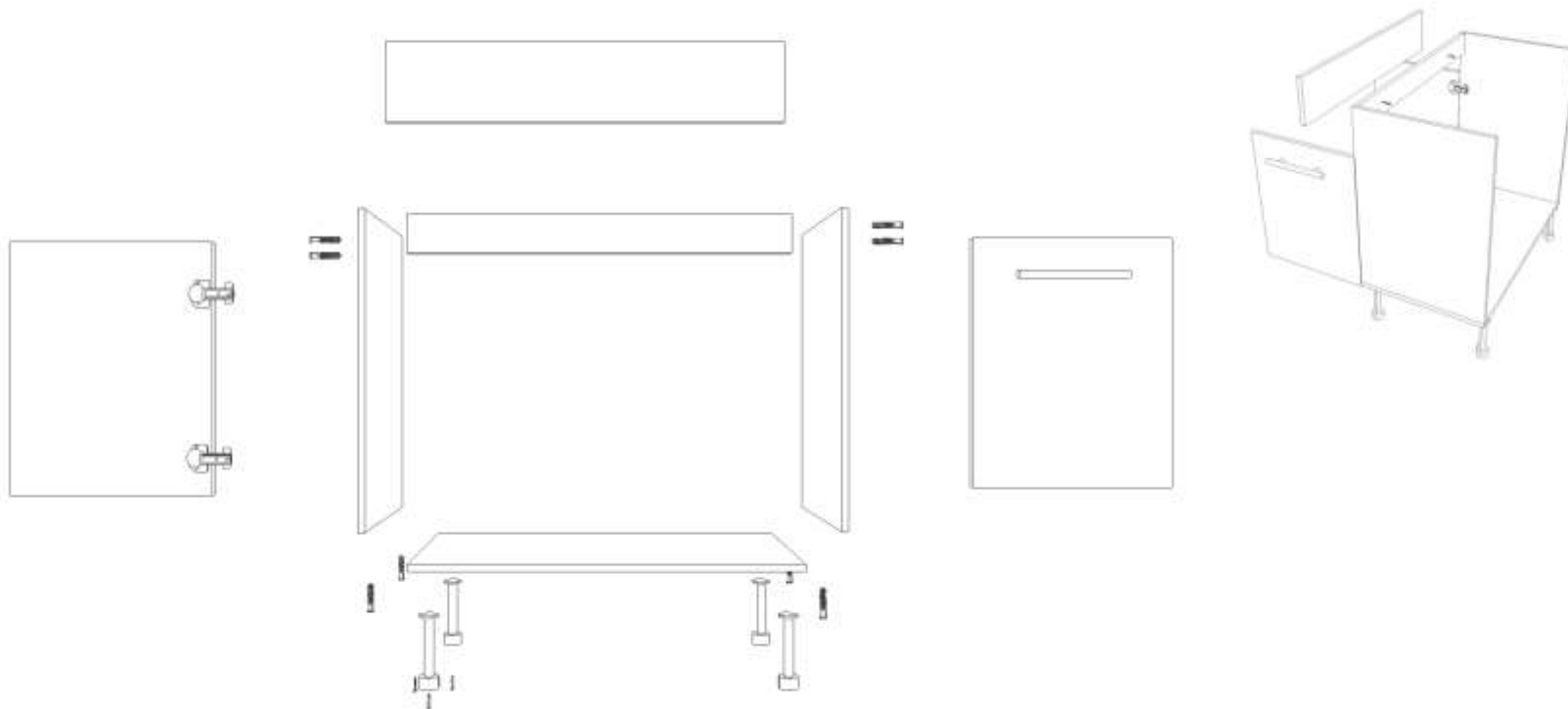

Se fixeaza picioarele cu cate 3 C2 (3,5x16)

Se fixeaza balamalele de usi apoi de LM cu C2 (3,5x16)

Se fixeaza manerele cu c3, apoi FF cu 2 buc C4

Schita de montaj corp bucatarie suspendat cu 1 usa



Eurosurub 7*50=8 buc c1



Surub cap inecat 3,5*16-12 buc c2



Maner metalic -1 buc c7



Surub maner m4*25mm-2 buc c3



Balama usa aplicata -2 buc c5



Surub cap inecat 2,5*20 -20 buc c8



Suport metalic raft 4 buc c10



Coltar metalic -2 buc c14

Necesita dibluri cu surub neincluse , in functie de structura peretelui

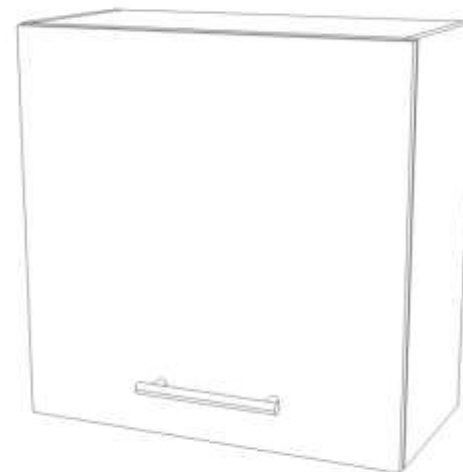

Lista piese:

Jos cod js6-568*280*2 buc

Laterală cod ls6-650*280*2 buc

Raft cod rms6 -568*260*1 buc

Front cod us6 -647*597*1 buc

Spate cod pfls6-645*595*1

Schita de montaj corp bucatarie suspendat cu 1 usa

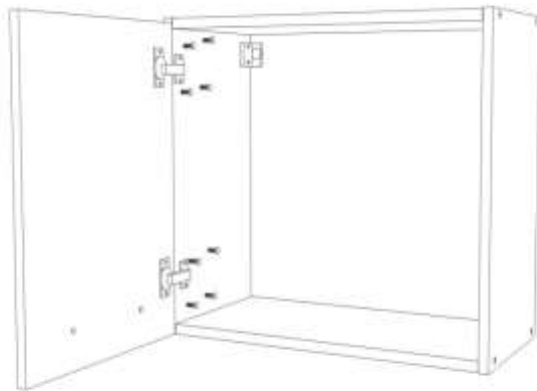
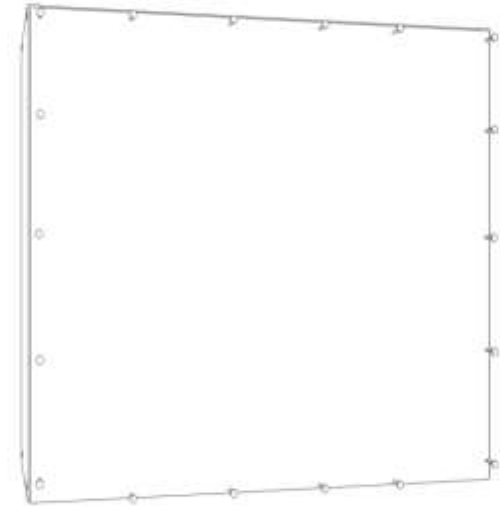
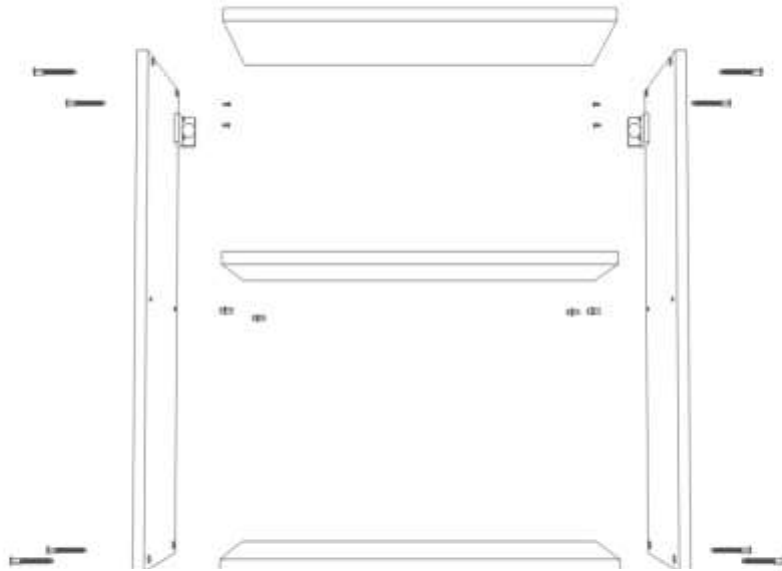

sau

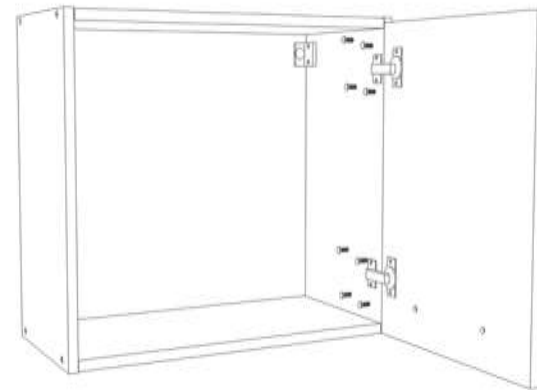

Schita de montaj corp bucatarie suspendat cu 2 usi



Eurosurub 7*50=12 buc c1



Surub cap inecat 3,5*16-20 buc c2



Maner metalic -2 buc c7



Surub maner m4*25mm-4 buc c3



Balama usa aplicata -2 buc c5



Cui 1,8x30mm -20 buc c8



Coltar metalic -2 buc c14

Necesita dibluri cu surub neincluse,
in functie de structura peretelui de
suspendat

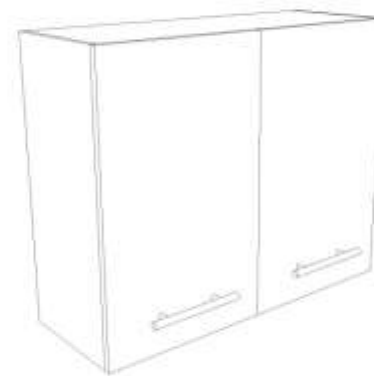

Lista piese:

Jos cod js6-768*280*2 buc

Laterală cod ls6-650*280*2 buc

Raft cod rfixs -768*270*1 buc







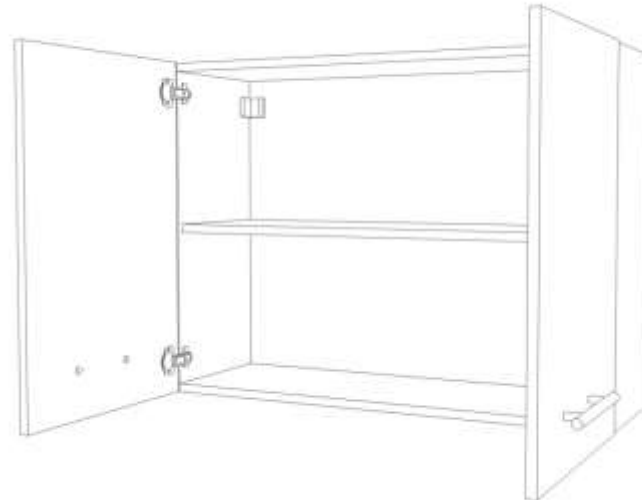
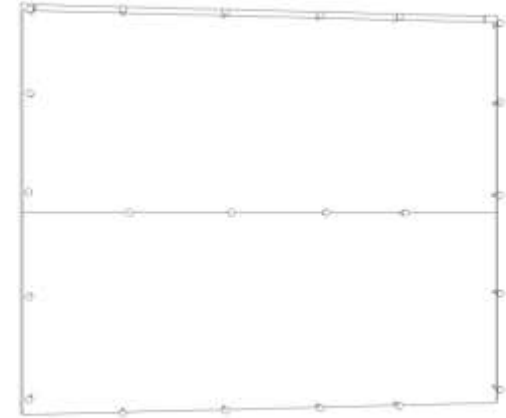
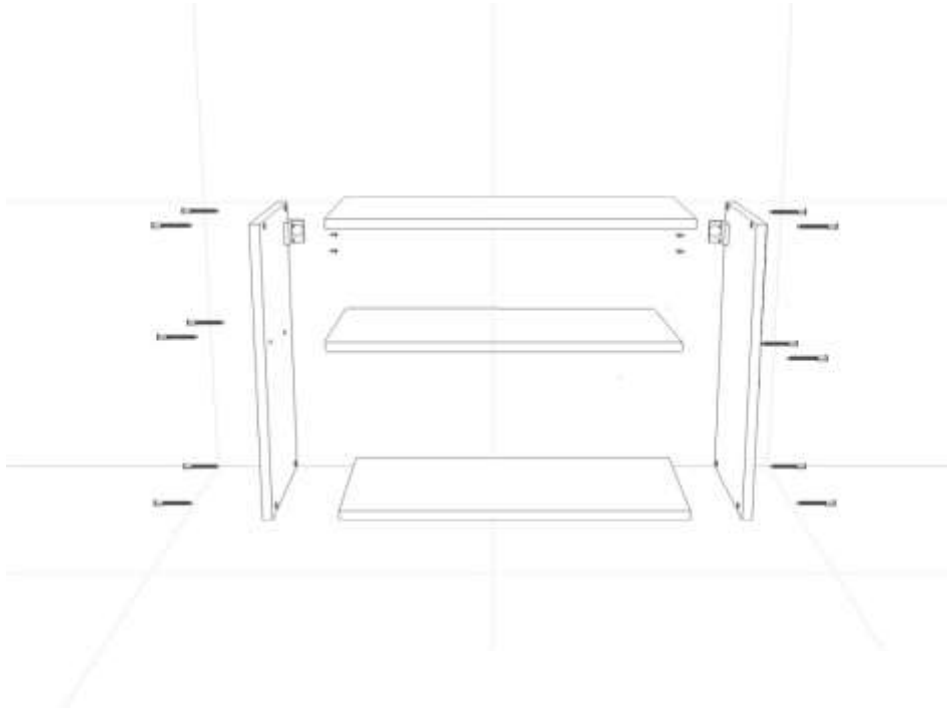

Front cod usv -647*447*2 buc

Spate cod pfls6-322*795*2

Schita de montaj corp bucatarie suspendat cu 2 usi Cu sticla sau pline



Schita de montaj Corp superior 600 1 usa , sau pentru hota*

-  Eurosurb 7*50-8 buc c1
-  Surub cap inecat 3,5*16-12buc-c2
-  Surub maner m4*25mm -2 buc-c3
-  Balama usa aplicata 2 buc-c5
-  Maner metalic -2 buc-c7
-  Surub cap inecat 2,5*20- 20 buc-c8
-  Coltar suspendare 2 buc-c14
-  *pentru hota necesita decupaje conducte



Lista piese:

- Jos cod tavan j -568*280-1 buc
- Sus cod tavan s-568*280-1buc
- Laterala cod lateral l- 500*280- buc
- Front cod usa h 492*597*1 buc
- Spate pfl cod pfl:595*495-1 buc



Schita de montaj Corp superior 600 1 usa , sau pentru hota*

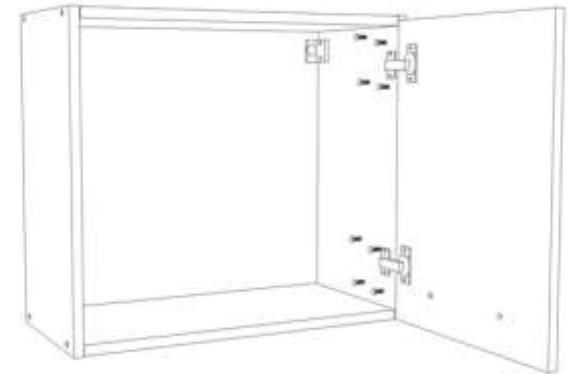
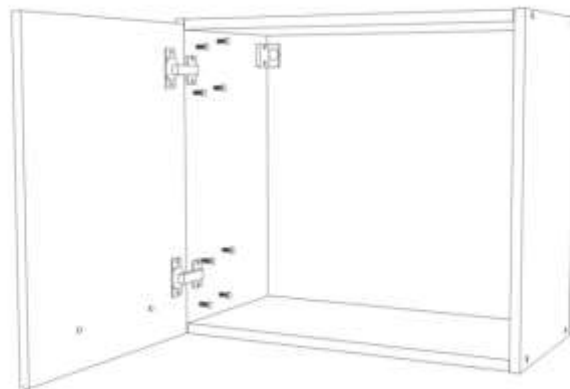
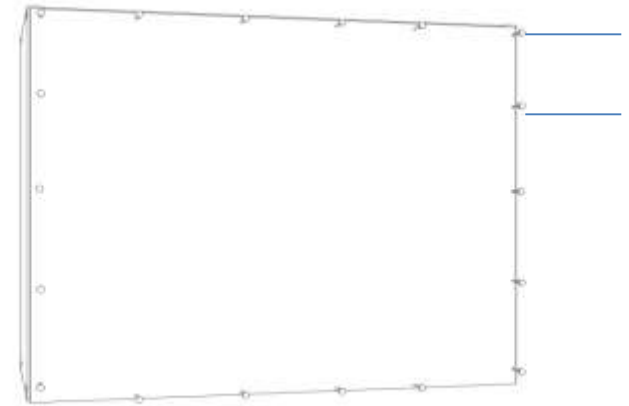
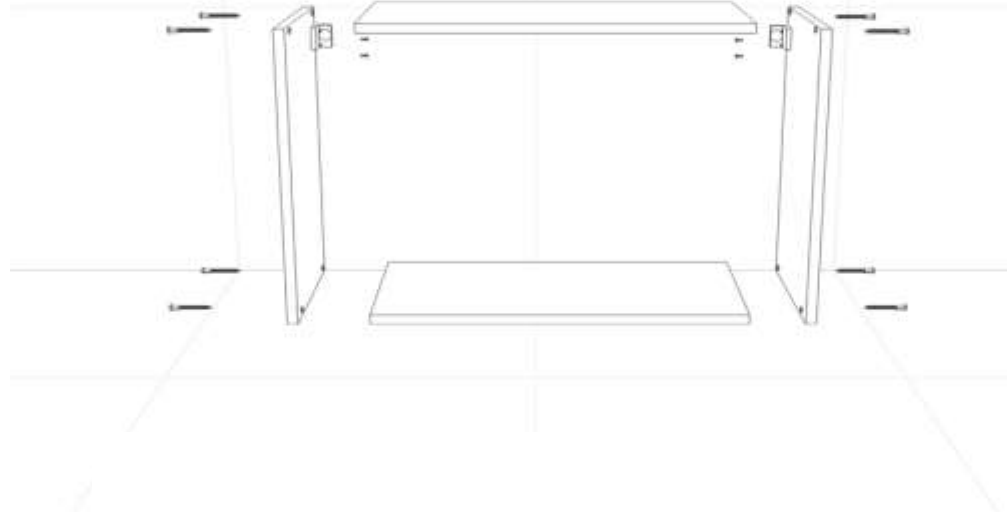



Eurosurub x 16 buc



Cep lemn 8*35x 32 buc



Picior x 4 buc



Holzsurub 3,5x16mmx32 buc



Balama 4 buc



Cui pfl spate 1,8x30mm=50 buc



Maner -2 buc



Surub maner 4 buc



Suport raft -12 buc

Placa jos F 600x550x1 buc
 Lateral LSD 1888x550x2 buc
 Placa sus T 600x550x1 buc
 Raft fix RF 568x550x2 buc
 Raft mobil 568x500x3 buc
 Usi 657x597x2 buc
 Pfl spate: 650x595x2 buc
 610x595x1 buc

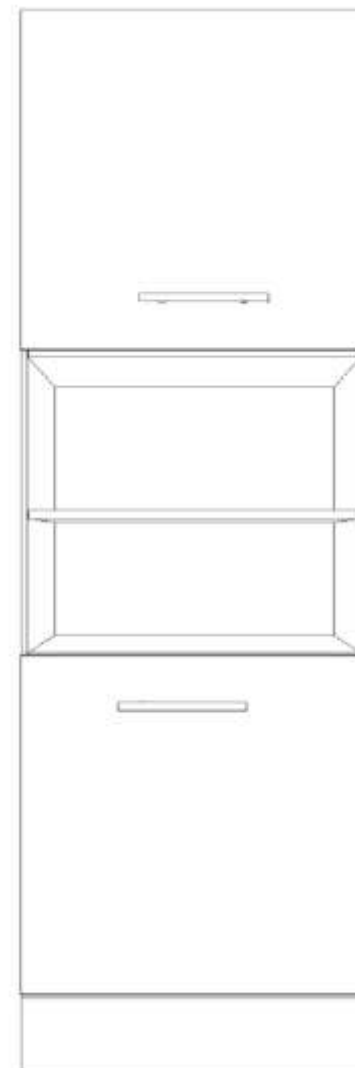

se monteaza cepurile de lemn in gaurile rafurilor fixe ,
apoi cu eurosuruburi se fixeaza LSD de RF

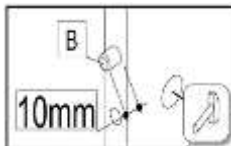

Se fixeaza PFL spate cu ajutorul cuielor 1,8x30 ,
cu diagonalele dulapului egale cu ajutorul ruletei , sau a unui vinclu

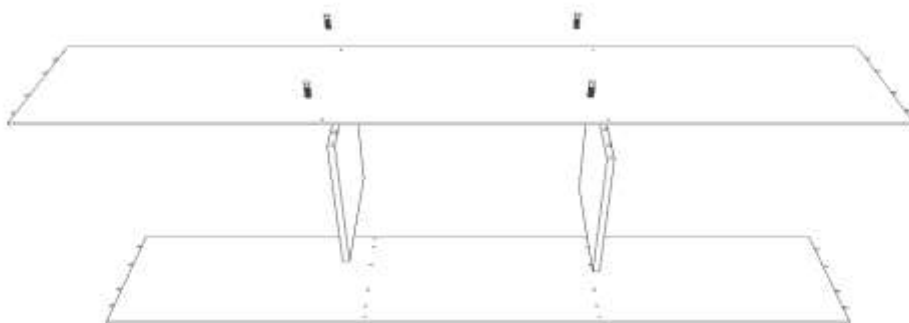

se monteaza cepurile de in lemn in gaurile LSD

Apoi se fixeaza T si F de ansamblu, cu eurosuruburi

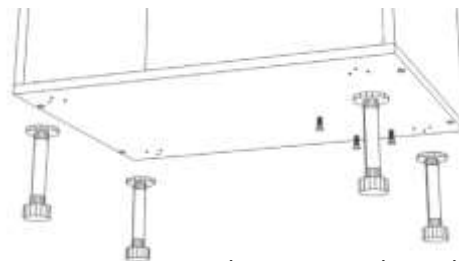
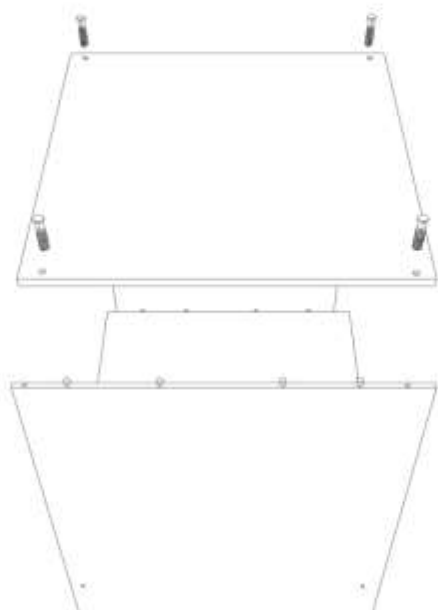

Se monteaza picioarele pe F cu Holzsuruburi 3,5x16

Se fixeaza suporurile de raft in gaurile de 5 mm, apoi se aseaza rafurile



Se monteaza balamalele pe usi cu 3,5x16 mm apoi se monteaza pe dulap , pe stanga sau
dreapta, apoi cu ajutorul unui burghiu de 5mm se strapung gaurile de maner